

DIMENSIONS

PORTES | FENÊTRES



2023

PORTES EN ACIER STEEL DOORS

FENÊTRES WINDOWS

PORTES PATIO PATIO DOORS

PORTES INTÉRIEURES INTERIOR DOORS

■ QUI NOUS SOMMES	3
WHO WE ARE	
■ PORTES EN ACIER	4
STEEL DOORS	
■ FENÊTRES	24
WINDOWS	
■ PORTES PATIO	40
PATIO DOORS	
■ PORTES INTÉRIEURES	54
INTERIOR DOORS	
■ NOTES	82

GARANTIES

Consultez notre site web www.dimensionspf.com pour les garanties applicables sur l'ensemble de nos produits.

Visit our website www.dimensionspf.com for the warranties available on all our products.

Dimensions portes et fenêtres est une entreprise familiale Canadienne. Depuis 1988, nous sommes chef de file dans le domaine des portes et fenêtres résidentielles.

Notre équipe dynamique a pour mission d'offrir des produits et un service de qualité exceptionnelle. Manufacturier de produits standards, nous sommes également les spécialistes du sur mesure ! Qu'il s'agisse d'un projet spécial, d'une construction neuve ou d'une rénovation, Dimensions a ce qu'il vous faut ! Nous sommes partenaire de tous vos projets.

Nos produits sont offerts à travers tout l'Est du Canada par le biais de nos distributeurs et nous assurons notre propre transport afin d'offrir le meilleur service qui soit.

Merci de choisir une entreprise de chez vous !

Dimensions Windows and doors is a Canadian family business. Since 1988, we have been a leader in the field of residential windows and doors.

Our dynamic team's mission is to offer exceptional quality products and service. Manufacturer of standard products, we are also custom-made specialists! Whether it's a special project, a new construction or a renovation, Dimensions is what you need! We are a partner for all your projects.

Our products are offered throughout Eastern Canada through our distributors and we provide our own transportation to provide the best possible service.

Thank you for choosing a company close to home!



TAO



ERA



**SOHO
(SHAKER)**
INVENTAIRE/STOCK



SYDNEY
INVENTAIRE/STOCK



ORLÉANS
INVENTAIRE/STOCK



B01
INVENTAIRE/STOCK



VOG
INVENTAIRE/STOCK



OSO



**VICTORIA
(SHAKER)**
INVENTAIRE/STOCK



LINEA

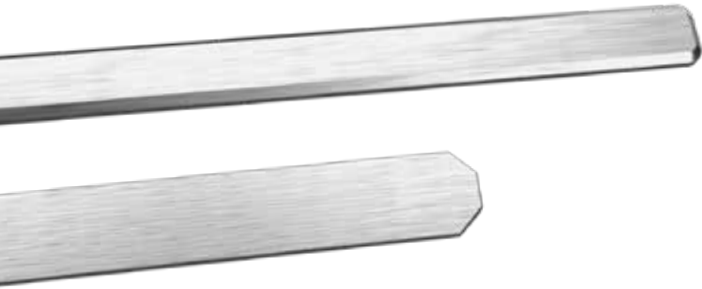

Donnez un caractère unique à votre entrée en y ajoutant des appliqués en ALUNOX. Un simple ajout qui donne un nouveau regard aux portes Uno, Vog et Oso de notre collection Design.

Customize your entrance and add character to our Design Collection steel doors with ALUNOX decorative elements. This simple addition transforms the look of our Uno, Vog and Oso doors.



ERA 1



OSO 1



OSO 2



VOG 1



VOG 2



UNO 1



UNO 2



Barrotins de surface 1 $\frac{1}{2}$ " en aluminium. Créez la porte de votre choix ou choisissez l'un des modèles suivants. Disponibles avec thermos clair ou givré. (Blanc satiné, diamanté, screen, glue-chip, etc.)

1 $\frac{1}{2}$ " aluminum surface mullions. Create the door of your choice or choose one of the following models. Available with clear or frosted thermal glass. (White satin, diamond, screen, glue-chip, etc.)

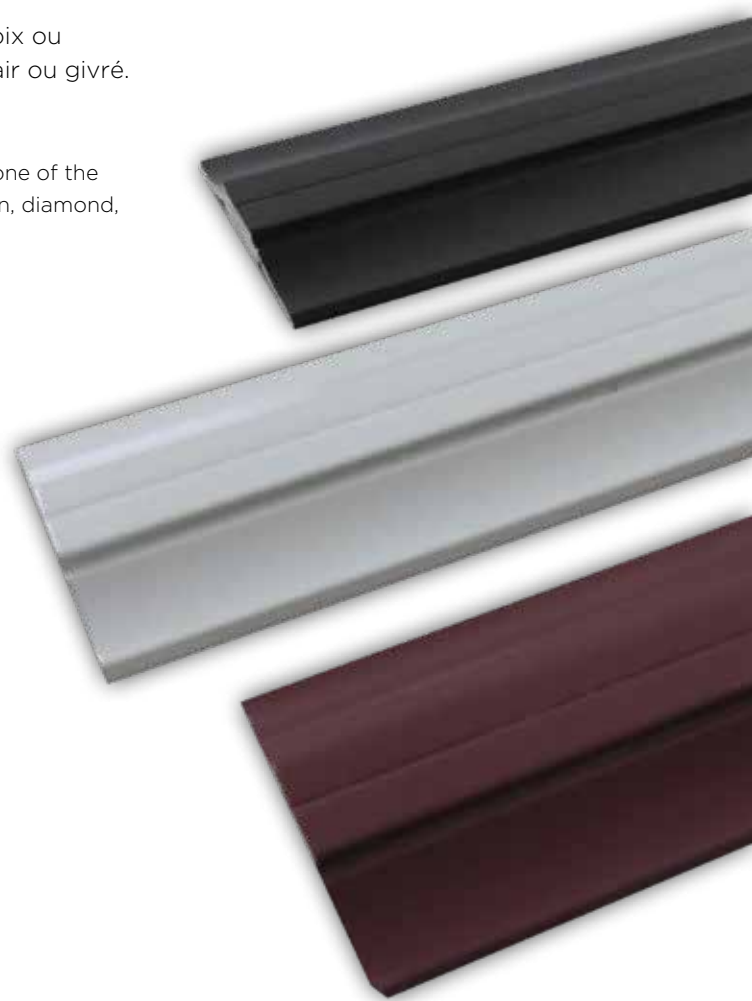

ORLBS – 22



A13BS – 14



VICBS – 31



SYDBS – 22



A13BS – 24

MÉCANISME AUTOMATIQUE



- Installation en usine des poignées multipoints.
Multipoint handles installed in the factory.



SÉRIE VENISE
VENISE SERIES



SÉRIE ALLEGRO
ALLEGRO SERIES



SÉRIE CAPRI
CAPRI SERIES

- **Couleurs disponibles / Available Colours**

Laiton antique / Antique Brass, Bronze foncé / Dark Bronze,
Étain / Pewter, Nickel satiné / Satin Nickel, Laiton poli / Polished Brass

MÉCANISME AUTOMATIQUE



SÉRIE BERKLEY
BERKLEY SERIES



SÉRIE ROMA
ROMA SERIES

- **Couleurs disponibles / Available Colours**

Noir / Black, Bronze foncé / Dark Bronze, Étain / Pewter,
Nickel satiné / Satin Nickel

CADRE DE PORTE EN ACIER STANDARD

STANDARD STEEL DOOR FRAME SYSTEM



* CERTAINES RESTRICTIONS S'APPLIQUENT
SOME RESTRICTIONS APPLY



Voici notre système de cadre en bois recouvert, éprouvé et amélioré depuis les 30 dernières années. Il offre le meilleur rapport qualité/prix de l'industrie et répond ou surpasse les normes canadiennes. Afin de s'adapter à tous vos besoins, une multitude d'options intéressantes sont disponibles !

Here's our clad wood frame system, tested and improved over the past 30 years. It offers the best value for money in the industry and meets or surpasses Canadian standards. In order to adapt to all your needs, numerous interesting options are available!

AVANTAGES

ADVANTAGES

- Notre système DIMENSIONS + éprouvé et amélioré depuis 30 ans pour offrir le meilleur rapport qualité/prix de l'industrie
Our DIMENSIONS + system tested and improved for 30 years to offer the best value for money in the industry
- Respectes les normes canadiennes de la NAFS
(rendement entre Classe LC - CP 30 et CP 40 disponible sur notre site web)
Meets NAFS Canadian standards (efficiency between LC Class - CP 30 and CP 40 available on our website)
- Assemblage avec broches et vis à écrous pour une solidité accrue
Assembly with pins and screws with nuts for greater strength
- Assemblage avec scellant entre les composantes de bois
Sealant assembly between wood components
- Système de bris thermique et lamelle avec bulle d'étanchéité
Thermal break and slat with sealing bubble system
- Système de coupe-froid compression
Compression weatherstrip system
- Bloc pour astragale maintenant renforcé
New reinforced twin door block



CADRE DE BOIS RECOUVERT EN ALUMINIUM

ALUMINIUM-CLAD WOOD FRAME

OPTIONS

OPTIONS

- Machinage de gâches sur le cadre
Striker plate groove on the frame
- Peinture extérieure ou intérieure du cadre de couleur sur mesure ou standard
Custom or standard paint colour on the outside or inside of the frame
- Battant de porte recouvert en PVC et coupe-froid
PVC-clad door leaf and weatherstrip
- Pentures à billes
Ball-bearing hinges
- Recouvrement extérieur en PVC ou en aluminium
PVC or aluminum exterior cladding
- Recouvrement en PVC ou en aluminium intérieur
PVC or aluminum interior cladding
- Moulures à brique
Brick moulding
- Seuil anodisé noir
Black anodized sill
- Seuil en granit (7 1/4" seulement)
Granit sill (7 1/4" only)
- Poignées multipoint
Multipoint handles



CADRE DE BOIS RECOUVERT EN PVC

PVC-CLAD WOOD FRAME

EXEMPLES DE CONFIGURATIONS POSSIBLES

CONFIGURATION POSSIBILITY EXAMPLES

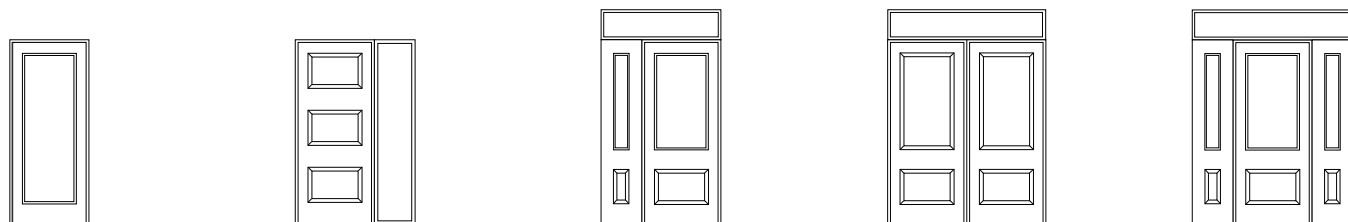

DISPONIBLE/AVAILABLE : 4^{5/8}, 6^{5/8}, 7^{1/4}, 8^{5/8}, 9^{1/4}, 9^{3/4} STANDARD



COLLECTION **PROMO**

Novatech[®]



BELMONT
(PATINÉ/PATINA)

MOULURE CONTEMPORAINE
10-387-060-002 (23X65)



MODÈLE 30^È ANNIVERSAIRE
30TH ANNIVERSARY MODEL

TRINTA
(SABLÉ/SANDBLAST)
PORTE SOHO
MOULURE CONTEMPORAINE
06-373-057-002



ALLURE
(ZINC)
PORTE ORLÉANS
10-002-057-004 (23X49) // 10-002-017-003 (9X49)



PURE
(FINI SABLÉ AVEC ENCRE NOIRE / SANDBLAST FINISHED WITH BLACK INK)
MOULURE CONTEMPORAINE
07-334-038-004 (21X65)



ALYS
(RAINURÉE/V-GROOVE)
PORTE ORLÉANS
06-322-057-001 (23X49) // 06-322-017-001 (9X49)



ÉVANGÉLINE II
(ZINC)

PORTE ORLÉANS

10-054-057-006 (23X49) // 10-054-017-005 (9X49)



BISTRO

(PATINÉE/PATINA)

PORTE ORLÉANS

10-258-057-001 (23X49) // 10-258-017-001 (9X49)



A-13 CONTEMPORAINE
(VERRE CLAIR/LOW-E)

MOULURE CONTEMPORAINE

08-079-038-141 (21X65)



CACHET

(ZINC)

PORTE ORLÉANS

10-230-057-003 (23X49) // 10-230-017-003 (9X49)



**NOUVEAU
NEW**

FARMHOUSE
(CAFA 2X2 / 1X2 DUO BLANC)
PORTE ORLÉANS
01-244-057-008 (23X49) // 01-244-017-006 (9X49)



**NOUVEAU
NEW**

SABLÉ/SANDBLAST 23X65
(SABLÉ/SANDBLAST LOW-E ARGON)
MOULURE CONTEMPORAINE
08-079-060-139



CACHET 23X15 ^{7/16}
(PATINÉ/PATINA)
PORTE VICTORIA
MOULURE CONTEMPORAINE
TABLETTE EN OPTION
10-230-260-011



**NOUVEAU
NEW**

SABLÉ/SANDBLAST 23X18
(SABLÉ/SANDBLAST LOW-E ARGON)
MOULURE CONTEMPORAINE
08-079-259-033



ZENITH
(RAINURÉE/Y-GROOVE)
MOULURE CONTEMPORAINE
06-347-060-002 (23X65)



EDGE
(VERRE SABLÉ, CONTOUR CLAIR/SANDBLAST, CLEAR PERIMETER)
MOULURE CONTEMPORAINE
08-079-060-202 (23X65)



AZUR
(SÉRIGRAPHIE/SILKSCREEN)
MOULURE CONTEMPORAINE
07-338-060-002 (23X65) // 07-338-005-001 (8X65)



MISTRAL
(PATINÉE/PATINA)
PORTE ORLÉANS
10-310-057-001 (23X49) // 10-310-017-001 (9X49)



**VERRE
SELECT**



LINEA HORIZONTAL 090 (3X)
MOULURE URBAINE
LIN090-LOWE-CONT (3X)

Les lignes épurées sont un élément clé de la collection contemporaine VERRE SELECT qui exsude un charisme moderne.

Ces vitraux à partir de nos nombreux verres décoratifs qui sauront mettre en valeur votre demeure tendance et en faire le sujet de conversation du quartier!



WHISTLER
(PLOMB ANTIQUE/ANTIQUE LEAD)
MOULURE URBAINE
PORTE SOHO
WHI104E-N-CURB



SCREEN 098 (4X)
MOULURE URBAINE
SCR-098-LOWE-CONT (4X)



AMADEUS
(PLOMB/LEAD)
PORTE ORLEAN XE PLUS
AMA104PL-LOWE (23X49) // AMA105PL-LOWE (9X49)



RODIN
(PLOMB/LEAD)
PORTE 300
ROD 104-PL (23"X49") // ROD 105-PL (9"X49")



FRAGRANCE
 (VERRE SABLÉ, ZONE CLAIRE / SANDBLAST GLASS, CLEAR ZONE)
PORTE SOHO
MOULURE URBAINE
 FRAT04-CURB-UPVC



CGB
 (SABLÉ CONTOUR CLAIR / SANDBLAST CLEAR PERIMETER)
PORTE SOHO
MOULURE URBAINE
 CBG1041-CURB-UPVC (23X48)



ENDRICK
 (NON SOUDÉ NOIR/NON WELDED BLACK)
MOULURE URBAINE
 END108NSE-NO-CURB-UPVC // END107NSE-NO-CURB-UPVC



VENUS
 (PLOMB ANTIQUE/ANTIQUE LEAD)
PORTE 300
 VEN 130-N (3/4" OVALE) // VEN 105-N (9X49)



D03
Clair Low-E Argon
Clear Low-E Argon



B03
Clair Low-E Argon
Clear Low-E Argon



B06 C.I.
Clair Low-E Argon
Clear Low-E Argon



UNO-23x18-3x
Clair/Clear low-E Argon
Moulure contemporaine
08-079-259-032

**NOUVEAU
NEW**



B02
Clair Low-E Argon
Clear Low-E Argon



D02
Clair Low-E Argon
Clear Low-E Argon



A13
Clair Low-E Argon
Clear Low-E Argon



**NOUVEAU
NEW**

VICTORIA-23x15 7/16
Clair/Clear low-E Argon
Moulure contemporaine
08-079-260-026



L18 C.I.
Clair Low-E Argon
Clear Low-E Argon



B01



A13 CC6B
Clair Low-E Argon
Clear Low-E Argon



D06 C.I.
Clair Low-E Argon
Clear Low-E Argon



A14 C.I.
Clair Low-E Argon
Clear Low-E Argon



CAAL10
Clair Low-E Argon
Clear Low-E Argon

SÉRIE COMMODITÉ - FACE EXTÉRIEURE NOIRE

BLACK EXTERIOR FACE COMMODITY SERIES



* CERTAINES RESTRICTIONS S'APPLIQUENT
SOME RESTRICTIONS APPLY

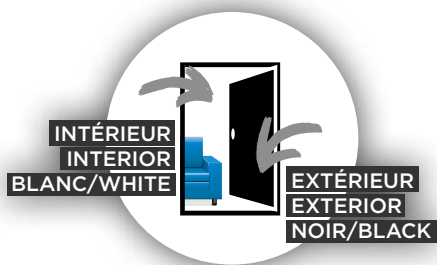

Profitez d'une rapidité de livraison et d'un prix avantageux sur ces modèles promotionnels **INVENTAIRE**. Offert avec la porte N600 prépeinte noire et moulure contemporaine noire dans la masse. (disponible seulement en porte simple)



Commandes rapides : 32", 34", 36"
Quick orders: 32", 34", 36"

Take advantage of speedy delivery and attractive prices on these **INVENTORY** promo models. Offered with the N600 black prepainted door and black contemporary moulding in the mass. (



CAFA 2X2 DUO NOIRE / BLACK
Clair/Clear Low-E Argon
01-244-057-042



CLAIR 22X48 NOIRE / BLACK
PORTE ORLÉAN
Clair/Clear Low-E Argon



ORLÉAN NOIRE / BLACK



B01 NOIRE / BLACK



B03 NOIRE / BLACK
Clair/Clear Low-E Argon



EDGE 22X64 NOIRE / BLACK
Sablé, Contour clair/Sandblast,clear perimeter
Low-E Argon



SABLÉ 22X64 NOIRE / BLACK
Sablé/Sandblast
Low-E Argon
08-079-060-301

**NOUVEAU
NEW**



A-13 22X64 NOIRE / BLACK
Clair/Clear Low-E Argon



PURE 22X64 NOIRE / BLACK
Fini sablé avec encre noire /
Sandblasted finished with black ink
Clair/Clear Low-E Argon



TRINTA 22x48 NOIRE / BLACK
PORTE ORLEAN
Sablé V-Groove Low-E Argon

FENÊTRES BATTANT/AUVENT/FIXE PVC

AWNING/CASEMENT/FIXED PVC WINDOWS

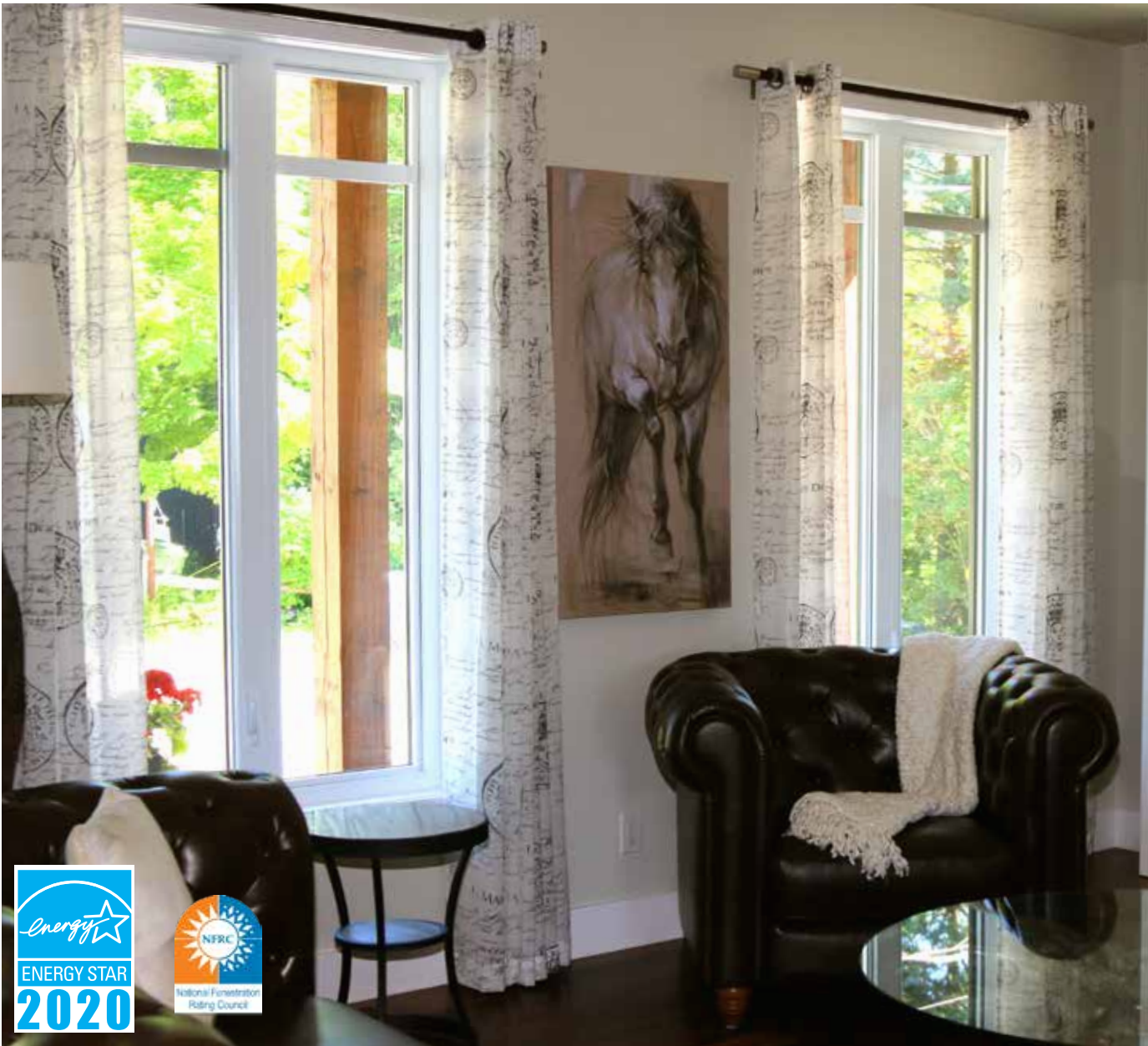

*CERTAINES RESTRICTIONS S'APPLIQUENT POUR LA CERTIFICATION ENERGY STAR 2020 / SOME RESTRICTIONS APPLY FOR ENERGY STAR 2020 CERTIFICATION



Volet Dimensions
Dimensions Sash



Volet contemporain
Contemporary Sash



Petit cadre fixe
Small Fixed Frame

SPÉCIFICATIONS SPECIFICATIONS

- Homologué par Energy Star 2020 (*certaines restrictions s'appliquent*)
Energy Star 2020 certified (some restrictions apply)
- Produit testé et qui respecte les normes de la NAFS
Product tested and complying with NAFS standards
- Cadre de 4^{1/2}" ou 5^{5/8}" favorisant le positionnement du vitrage dans la partie chaude du mur
4^{1/2}" or 5^{5/8}" frame accommodating the positioning of the glass within the warm part of the wall
- Volet d'étanchéité maximale incorporant 3 coupe-froid noirs
Maximum tightness sash with 3 embedded black weatherstrips



OPTIONS OPTIONS

- Volet de style **DIMENSIONS** exclusif ou **CONTEMPORAIN**
DIMENSIONS exclusive or CONTEMPORARY style sash
- Unité scellée en verre **DOUBLE** ou **TRIPLE**
DOUBLE or TRIPLE glazed sealed units
- Intercalaire en acier inoxydable **INTERCEPT ULTRA** (standard) ou **TECHNOFORM** (optionnel)
INTERCEPT ULTRA (standard) or TECHNOFORM (optional) stainless steel spacer
- Multitude de moulures à brique et option d'installation (voir page 41)
Multitude of brick mouldings and optional installation (see page 41)

QUINCAILLERIE HARDWARE

- Mécanisme d'ouverture à manivelle repliable de qualité **EN ACIER INOXYDABLE GARANTI À VIE**
Quality LIFETIME GUARANTEED STAINLESS STEEL folding crank handle opening mechanism



EXEMPLES DE CONFIGURATIONS CONFIGURATION EXAMPLES



PERFORMANCES

BATTANT PVC | CASEMENT..... NAFS-08
CSA A440-00

Infiltration/exfiltration d'air - Air infiltration/exfiltration :	A3	A3
Infiltration d'eau - Water resistance :	100	B7
Pression de calcul - Design pressure :	PC75	C5
Désignation principale - Primary designator :	LC-CP75 800 X 1500 (32 X 59) Type C	

AUVENT PVC | AWNING NAFS-08 CSA
A440-00

Infiltration/exfiltration d'air - Air infiltration/exfiltration :	A3	A3
Infiltration d'eau - Water resistance :	100	B7
Pression de calcul - Design pressure :	PC50	C3
Désignation principale - Primary designator	LC-CP50 1200 X 800 (47 X 32) Type AP	

VOLETS FIXES | FIXED FRAME NAFS-08 CSA
A440-00

Infiltration/exfiltration d'air - Air infiltration/exfiltration :	A3	Fixe
Infiltration d'eau - Water resistance :	100	B7
Pression de calcul - Design pressure :	PC70	PC75
Désignation principale - Primary designator	CW-CP75 1500 X 1500 (59 X 59) Type FW	



PEINTURE PAINT

Peinture disponible sur l'extérieur et l'intérieur, couleurs Gentek ou sur mesure.
Paint available on the exterior and interior, Gentek or custom colours

FENÊTRES BATTANT/AUVENT/FIXE HYBRIDES ALUMINIUM

AWNING/CASEMENT/FIXED HYBRID ALUMINUM WINDOWS



*CERTAINES RESTRICTIONS S'APPLIQUENT POUR LA CERTIFICATION ENERGY STAR 2020 / SOME RESTRICTIONS APPLY FOR ENERGY STAR 2020 CERTIFICATION



Volet Dimensions
Dimensions Sash



Volet contemporain
Contemporary Sash



Petit cadre fixe
Small Fixed Frame



Grand cadre fixe
Large Fixed Frame

SPÉCIFICATIONS SPECIFICATIONS

- Homologué par Energy Star 2020 (*certaines restrictions s'appliquent*)
Energy Star 2020 certified (some restrictions apply)
- Produit testé et qui respecte les normes de la NAFS
Product tested and complying with NAFS standards
- Extrusion d'aluminium de qualité avec peinture cuite de norme AAMA 2604
Quality aluminum extrusion using powder coat paint complying with AAMA 2604 standards
- Cadre de 4^{1/2}" ou 5^{5/8}" favorisant le positionnement du vitrage dans la partie chaude du mur
4 1/2" or 5 5/8" frame accommodating the positioning of the glass within the warm part of the wall
- Volet d'étanchéité maximale incorporant 3 coupe-froid noirs
Maximum tightness sash with 3 embedded black weatherstrips



OPTIONS OPTIONS

- Volet de style **DIMENSIONS** exclusif ou **CONTEMPORAIN**
DIMENSIONS exclusive or CONTEMPORARY style sash
- Unité scellée en verre **DOUBLE** ou **TRIPLE**
DOUBLE or TRIPLE glazed sealed units
- Multitude de moulures à brique et option d'installation (voir page 41)
Multitude of brick mouldings and optional installation (see page 41)
- Intercalaire en acier inoxydable **INTERCEPT ULTRA** (standard) ou **TECHNOFORM** (optionnel)
INTERCEPT ULTRA (standard) or TECHNOFORM (optional) stainless steel spacer

QUINCAILLERIE HARDWARE

- Mécanisme d'ouverture à manivelle repliable de qualité **EN ACIER INOXYDABLE GARANTI À VIE**
Quality LIFETIME GUARANTEED STAINLESS STEEL folding crank handle opening mechanism



EXEMPLES DE CONFIGURATIONS CONFIGURATION EXAMPLES



PERFORMANCES

BATTANT HYBRIDE HYBRID CASEMENT	NAFS-08	CSA-A440-00
Infiltration/exfiltration d'air - Air infiltration/exfiltration :	A3	A3
Infiltration d'eau - Water resistance :	100	B7
Pression de calcul - Design pressure :	PC85	C5
Désignation principale - Primary designator :	LC-CP85 800 X 1500 (32 X 59) Type C	
AUVENT HYBRIDE HYBRID AWNING	NAFS-08	CSA A440-00
Infiltration/exfiltration d'air - Air infiltration/exfiltration :	A3	A3
Infiltration d'eau - Water resistance :	100	B7
Pression de calcul - Design pressure :	PC50	C3
Désignation principale - Primary designator	LC-CP50 1200 X 800 (47 X 32) Type AP	
VOLETS FIXES FIXED FRAME	NAFS-08	CSA A440-00
Infiltration/exfiltration d'air - Air infiltration/exfiltration :		A3 Fixe
Infiltration d'eau - Water resistance :	100	B7
Pression de calcul - Design pressure :	DP85	C5
Désignation principale - Primary designator	CW-PG85 1500 X 1500 (59 X 59) Type FW	



PEINTURE PAINT

Peinture disponible sur l'extérieur et l'intérieur, couleurs Gentek ou sur mesure.
Paint available on the exterior and interior, Gentek or custom colours

COULEURS COLOURS

Couleurs de série disponibles en peinture électrostatique
Standard colours available in powder-coat paint

	Blanc White		Anodisé clair Clear anodized
	Noir Black		Brun commercial Commercial brown
	Charbon Slate		

FENÊTRES BATTANT/AUVENT/FIXE ALUMINIUM

AWNING/CASEMENT/FIXED ALUMINUM WINDOWS



*CERTAINES RESTRICTIONS S'APPLIQUENT POUR LA CERTIFICATION ENERGY STAR 2020 / SOME RESTRICTIONS APPLY FOR ENERGY STAR 2020 CERTIFICATION



Volet Dimensions
Dimensions Sash



Grand cadre fixe
Large Fixed Frame



Petit cadre fixe
Small Fixed Frame



Volet contemporain
Contemporary Sash

SPÉCIFICATIONS SPECIFICATIONS

- Homologué par Energy Star 2020 avec thermos triple (certaines restrictions s'appliquent)
Energy Star 2020 certified with Triple sealed units (some restrictions apply)
- Assemblage modulaire.
Modular Assembly.
- Extrusion d'aluminium de qualité avec peinture cuite de norme AAMA 2604.
Quality aluminum extrusion using powder coat paint complying with AAMA 2604 standards.
- Intercalaire TECHNOFORM noir de série.
Black TECHNOFORM spacer standard.
- Cadre 4^{1/2}" et 5^{5/8}".
4 1/2" and 5 5/8" frame.
- Moulure à brique en aluminium (3/4 et 1^{1/2} ouvert ou fermé).
Aluminum brick moulding (3/4 and 1 1/2" open or closed).
- Moustiquaire extrudé (assemblage 45°).
Extruded screen track (45° assembled).
- Support d'installation décalé inclus.
Offset installation bracket Included.
- Barrure et manivelle de style contemporain.¹ Gâches des volets ouvrants noirs.
Contemporary lock and crank handle¹. Black Strike plate on opening Sashes.



OPTIONS

- Volet de style **DIMENSIONS** exclusif ou **CONTEMPORAIN**
DIMENSIONS exclusive or CONTEMPORARY style sash
- Unité scellée en verre **DOUBLE** ou **TRIPLE**
DOUBLE or TRIPLE glazed sealed units
- Multitude de moulures à brique et option d'installation (voir page 41)
Multitude of brick mouldings and optional installation (see page 41)

QUINCAILLERIE HARDWARE

- Mécanisme d'ouverture à manivelle repliable de qualité **EN ACIER INOXYDABLE GARANTI À VIE**
Quality LIFETIME GUARANTEED STAINLESS STEEL folding crank handle opening mechanism

EXEMPLES DE CONFIGURATIONS CONFIGURATION EXAMPLES



PERFORMANCES

	LC	CW
BATTANT/AUVENT CASEMENT/AWNING	NAFS-11	NAFS-11
Infiltration/exfiltration d'air - Air infiltration/exfiltration :	A3	A3
Infiltration d'eau - Water resistance :	720Pa (100)	720Pa (100)
Pression de calcul - Design pressure :	3600Pa (75)	2880Pa (60)
Désignation principale - Primary designator :	LC-CP75 800 X 1500 (32 X 59) Type C	CW-CP60 800 X 1500 (32 X 59) Type C
GRAND CADRE FIXE LARGE FIXED FRAME	NAFS-11	
Infiltration/exfiltration d'air - Air infiltration/exfiltration :	A3	
Infiltration d'eau - Water resistance :	720Pa (100)	
Pression de calcul - Design pressure :	3600Pa (75)	
Désignation principale - Primary designator	CW-CP75 1500 X 1500 (59 X 59) Type FW	
PETIT CADRE FIXE SMALL FIXED FRAME	NAFS-11	
Infiltration/exfiltration d'air - Air infiltration/exfiltration :	A3	
Infiltration d'eau - Water resistance :	720Pa (100)	
Pression de calcul - Design pressure :	4320Pa (90)	
Désignation principale - Primary designator	CW-CP90 1500 X 1500 (59 X 59) Type FW	

COULEURS COLOURS

Couleurs de série disponibles en peinture électrostatique
Standard colours available in powder-coat paint

EXT.

	Blanc White		Anodisé clair Clear anodized
	Noir Black		Brun commercial Commercial brown
	Charbon Slate		

INT.

	Blanc Int. / Ext.		Anodisé clair Clear anodized Int. / Ext.
	Noir Black Int. / Ext.		Brun commercial Commercial brown

GUILLOTINE SIMPLE OU DOUBLE PVC

SINGLE OR DOUBLE PVC HUNG



*CERTAINES RESTRICTIONS S'APPLIQUENT POUR LA CERTIFICATION ENERGY STAR 2020 / SOME RESTRICTIONS APPLY FOR ENERGY STAR 2020 CERTIFICATION



Volet Contemporain simple
Single Contemporary Sash



Volet Contemporain double
Double Contemporary Sash



Volet Dimensions simple
Single Dimensions Sash



Volet Dimensions double
Double Dimensions Sash

SPECIFICATIONS SPECIFICATIONS

- Homologué par Energy Star 2020 (*certaines restrictions s'appliquent*)
Energy Star 2020 certified (some restrictions apply)
- Produit testé et qui respecte les normes de la NAFS
Product tested and complying with NAFS standards
- Cadre de 4^{1/2}" et 5^{5/8}" favorisant le positionnement du vitrage dans la partie chaude du mur
4 1/2" and 5 5/8" frame accommodating the positioning of the glass within the warm part of the wall
- Quincaillerie de qualité supérieure
Superior quality hardware

OPTIONS OPTIONS

- Volet de style **DIMENSIONS** exclusif ou **CONTEMPORAIN**
DIMENSIONS exclusive or CONTEMPORARY style sash
- Unité scellée en verre **DOUBLE** ou **TRIPLE** (Cadre 5^{5/8}" seulement)
DOUBLE or TRIPLE (5 5/8" frame only) glazed sealed units
- Intercalaire en acier inoxydable **INTERCEPT ULTRA** (standard) ou **TECHNOFORM** (optionnel)
INTERCEPT ULTRA (standard) or TECHNOFORM (optional) stainless steel spacer
- Multitude de moulures à brique et option d'installation (voir page 41)
Multitude of brick mouldings and optional installation (see page 41)



QUINCAILLERIE HARDWARE

- Barrure automatique pratique et quincaillerie de qualité supérieure.
Handy automatic lock and superior quality hardware



EXEMPLES DE CONFIGURATIONS CONFIGURATION EXAMPLES

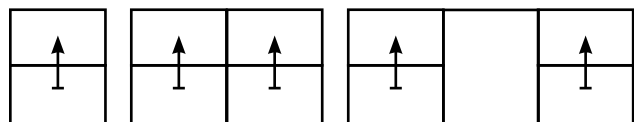

PERFORMANCES

GUILLOTINE SIMPLE SINGLE HUNG	NAFS-08	CSA-A440-00
Infiltration/exfiltration d'air - Air infiltration/exfiltration :	A3	A3/F
Infiltration d'eau - Water resistance :	45	B3
Pression de calcul - Design pressure :	PC80	C5
Désignation principale - Primary designator :	RC-P45 1000 X 1600 (39 X 63) Type H	RC-CP80 1000 x 1600 (39 x 63) Type H
GUILLOTINE DOUBLE DOUBLE HUNG	NAFS-08	CSA-A440-00
Infiltration/exfiltration d'air - Air infiltration/exfiltration :	A3	A3/F
Infiltration d'eau - Water resistance :	40	B3
Pression de calcul - Design pressure :	PC55	C5
Désignation principale - Primary designator :	RC-P40 1000 X 1600 (39 X 63) Type H	RC-CP55 1000 x 1600 (39 x 63) Type H



PEINTURE PAINT

Peinture disponible sur l'extérieur, couleurs Gentek ou sur mesure.
Paint available on the exterior, Gentek or custom colours

GUILLOTINE SIMPLE OU DOUBLE HYBRIDE ALUMINUM

SINGLE OR DOUBLE HYBRID ALUMINUM HUNG



*CERTAINES RESTRICTIONS S'APPLIQUENT POUR LA CERTIFICATION ENERGY STAR 2020 / SOME RESTRICTIONS APPLY FOR ENERGY STAR 2020 CERTIFICATION



Volet Dimensions simple
Single Dimensions Sash



Volet Dimensions double
Double Dimensions Sash



Volet contemporain simple
Single Contemporary Sash



Volet contemporain double
Double Contemporary Sash

SPÉCIFICATIONS SPECIFICATIONS

- Homologué par Energy Star 2020 (*certaines restrictions s'appliquent*)
Energy Star 2020 certified (some restrictions apply)
- Produit testé et qui respecte les normes de la NAFS
Product tested and complying with NAFS standards
- Cadre de 4^{1/2}" et 5^{5/8}" favorisant le positionnement du vitrage dans la partie chaude du mur
4 1/2" et 5 5/8" frame accommodating the positioning of the glass within the warm part of the wall
- Quincaillerie de qualité supérieure
Superior quality hardware
- Extrusion d'aluminium de qualité avec peinture cuite de norme AAMA 2604
Quality aluminum extrusion using powder coat paint complying with AAMA 2604 standards



OPTIONS OPTIONS

- Volet de style **DIMENSIONS** exclusif ou **CONTEMPORAIN**
DIMENSIONS exclusive or CONTEMPORARY style sash
- Unité scellée en verre **DOUBLE** ou **TRIPLE** (Cadre 5^{5/8}" seulement)
DOUBLE or TRIPLE (5 5/8" frame only) glazed sealed units
- Intercalaire en acier inoxydable **INTERCEPT ULTRA** (standard) ou **TECHNOFORM** (optionnel)
INTERCEPT ULTRA (standard) or TECHNOFORM (optional) stainless steel spacer
- Multitude de moulures à brique et option d'installation (voir page 41)
Multitude of brick mouldings and optional installation (see page 41)

QUINCAILLERIE HARDWARE

- Barrure automatique pratique et quincaillerie de qualité supérieure.
Handy automatic lock and superior quality hardware



EXEMPLES DE CONFIGURATIONS CONFIGURATION EXAMPLES

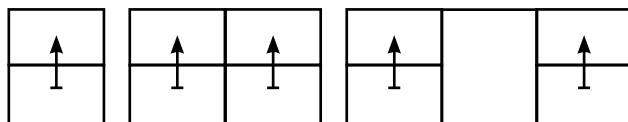

PERFORMANCES

GUILLOTINE SIMPLE HYBRIDE HYBRID SINGLE HUNG NAFS-08	CSA-A440-00
Infiltration/exfiltration d'air - <i>Air infiltration/exfiltration</i> :	A3 A3/F
Infiltration d'eau - <i>Water resistance</i> :	40 B3
Pression de calcul - <i>Design pressure</i> :	PC70/PC75 C4/C5
Désignation principale - <i>Primary designator</i> :	R-CP40 1000 x 1600 (39 x 63) Type H R-CP65 1000 x 1600 (39 x 63) Type H
GUILLOTINE DOUBLE HYBRIDE HYBRID DOUBLE HUNG NAFS-08	CSA-A440-00
Infiltration/exfiltration d'air - <i>Air infiltration/exfiltration</i> :	A3 A3
Infiltration d'eau - <i>Water resistance</i> :	40 B3
Pression de calcul - <i>Design pressure</i> :	PC55/PC65 C4
Désignation principale - <i>Primary designator</i> :	R-CP40 1000 x 1600 (39 x 63) Type H R-CP65 1000 x 1600 (39 x 63) Type H



PEINTURE PAINT

Peinture disponible sur l'extérieur, couleurs Gentek ou sur mesure.
Paint available on the exterior, Gentek or custom colours

COULEURS COLOURS

Couleurs de série disponibles en peinture électrostatique
Standard colours available in powder-coat paint

	Blanc White		Anodisé clair Clear anodized
	Noir Black		Brun commercial Commercial brown
	Charbon Slate		

FENÊTRES COULISSANTES SIMPLE OU DOUBLE PVC

SINGLE OR DOUBLE PVC SLIDING WINDOWS



*CERTAINES RESTRICTIONS S'APPLIQUENT POUR LA CERTIFICATION ENERGY STAR 2020 / SOME RESTRICTIONS APPLY FOR ENERGY STAR 2020 CERTIFICATION



Volet Contemporain simple
Single Contemporary Sash



Volet Contemporain double
Double Contemporary Sash



Volet Dimensions simple
Single Dimensions Sash



Volet Dimensions double
Double Dimensions Sash

SPÉCIFICATIONS SPECIFICATIONS

- Homologué par Energy Star 2020 (*certaines restrictions s'appliquent*)
Energy Star 2020 certified (some restrictions apply)
- Produit testé et qui respecte les normes de la NAFS
Product tested and complying with NAFS standards
- Cadre de 4 1/2" et 5 5/8" favorisant le positionnement du vitrage dans la partie chaude du mur
4 1/2" et 5 5/8" frame accommodating the positioning of the glass within the warm part of the wall
- Quincaillerie de qualité supérieure
Superior quality hardware



OPTIONS OPTIONS

- Volet de style **DIMENSIONS** exclusif ou **CONTEMPORAIN**
DIMENSIONS exclusive or CONTEMPORARY style sash
- Unité scellée en verre **DOUBLE** ou **TRIPLE** (Cadre 5 5/8" seulement)
DOUBLE or TRIPLE (5 5/8" frame only) glazed sealed units
- Intercalaire en acier inoxydable **INTERCEPT ULTRA** (standard) ou **TECHNOFORM** (optionnel)
INTERCEPT ULTRA (standard) or TECHNOFORM (optional) stainless steel spacer
- Multitude de moulures à brique et option d'installation (voir page 41)
Multitude of brick mouldings and optional installation (see page 41)

QUINCAILLERIE HARDWARE

- Barrure automatique pratique et quincaillerie de qualité supérieure.
Handy automatic lock and superior quality hardware



EXEMPLES DE CONFIGURATIONS CONFIGURATION EXAMPLES

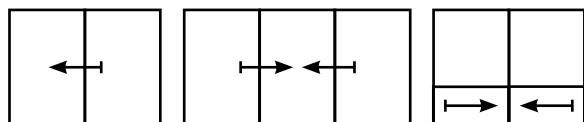

PERFORMANCES

COULISSANTE SIMPLE SINGLE SLIDING	NAFS-08	CSA A440-00
Infiltration/exfiltration d'air - Air infiltration/exfiltration :	A3	A3/F
Infiltration d'eau - Water resistance :	50	B3
Pression de calcul - Design pressure :	PC45/PC65	C4
Désignation principale - Primary designator :	R-CP45 1600 X 1100 (63 X 43) TYPE HS	R-CP65 1600 X 1100 (63 X 43) TYPE HS
COULISSANTE DOUBLE DOUBLE SLIDING	NAFS-08	CSA A440-00
Infiltration/exfiltration d'air - Air infiltration/exfiltration :		A3 A3
Infiltration d'eau - Water resistance :	40	B3
Pression de calcul - Design pressure :	PC50/PC45	C2/C3
Désignation principale - Primary designator	LC-CP50 1200 X 800 (47 X 32) Type AP	



PEINTURE PAINT

Peinture disponible sur l'extérieur, couleurs Gentek ou sur mesure.
Paint available on the exterior, Gentek or custom colours

FENÊTRES COULISSANTES SIMPLE OU DOUBLE HYBRIDE ALUMINUM

SINGLE OR DOUBLE HYBRID ALUMINUM SLIDING WINDOWS



*CERTAINES RESTRICTIONS S'APPLIQUENT POUR LA CERTIFICATION ENERGY STAR 2020 / SOME RESTRICTIONS APPLY FOR ENERGY STAR 2020 CERTIFICATION



Volet Dimensions simple
Single Dimensions Sash



Volet Dimensions double
Double Dimensions Sash



Volet contemporain simple
Single Contemporary Sash



Volet contemporain double
Double Contemporary Sash

SPÉCIFICATIONS SPECIFICATIONS

- Homologué par Energy Star 2020 (*certaines restrictions s'appliquent*)
Energy Star 2020 certified (some restrictions apply)
- Produit testé et qui respecte les normes de la NAFS
Product tested and complying with NAFS standards
- Cadre en PVC soudé par fusion avec de multiples chambres d'air
Fusion welded PVC frame with multiple air spaces
- Cadre de 4^{1/2}" et 5^{5/8}" favorisant le positionnement du vitrage dans la partie chaude du mur
4 1/2" and 5 5/8" frame accommodating the positioning of the glass within the warm part of the wall
- Extrusion d'aluminium de qualité avec peinture cuite de norme AAMA 2604
Quality aluminum extrusion using powder coat paint complying with AAMA 2604 standards
- Quincaillerie de qualité supérieure
Superior quality hardware



OPTIONS OPTIONS

- Volet de style **DIMENSIONS** exclusif ou **CONTEMPORAIN**
DIMENSIONS exclusive or CONTEMPORARY style sash
- Unité scellée en verre **DOUBLE** ou **TRIPLE** (Cadre 5^{5/8}" seulement)
DOUBLE or TRIPLE (5 5/8" frame only) glazed sealed units
- Intercalaire en acier inoxydable **INTERCEPT ULTRA** (standard) ou **TECHNOFORM** (optionnel)
INTERCEPT ULTRA (standard) or TECHNOFORM (optional) stainless steel spacer
- Multitude de moulures à brique et option d'installation (voir page 41)
Multitude of brick mouldings and optional installation (see page 41)

QUINCAILLERIE HARDWARE

- Barrure automatique pratique et quincaillerie de qualité supérieure.
Handy automatic lock and superior quality hardware



EXEMPLES DE CONFIGURATIONS CONFIGURATION EXAMPLES

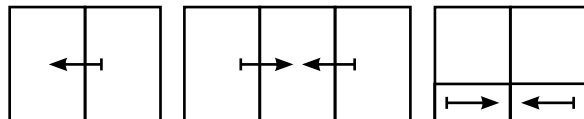

PERFORMANCES

COULISSANTE SIMPLE SINGLE SLIDING	NAFS-08	CSA A440-00
Infiltration/exfiltration d'air - Air infiltration/exfiltration :	A3	A3/F
Infiltration d'eau - Water resistance :	35	B2
Pression de calcul - Design pressure :	PC55/PC75	C4/C5
Désignation principale - Primary designator :	R-CP35 1600 X 1100 (63 X 43) TYPE HS R-CP55 1600 X 1100 (63 X 43) TYPE HS	
COULISSANTE DOUBLE DOUBLE SLIDING	NAFS-08	CSA A440-00
Infiltration/exfiltration d'air - Air infiltration/exfiltration :		A3 A3
Infiltration d'eau - Water resistance :	30	B2
Pression de calcul - Design pressure :	PC55/PC50	C3
Désignation principale - Primary designator :	R-CP30 1600 X 1100 (63 X 43) TYPE HS R-CP50 1600 X 1100 (63 X 43) TYPE HS	



PEINTURE PAINT

Peinture disponible sur l'extérieur, couleurs Gentek ou sur mesure.

Paint available on the exterior, Gentek or custom colours

COULEURS COLOURS

Couleurs de série disponibles en peinture électrostatique

Standard colours available in powder-coat paint



Blanc
White

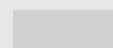

Anodisé clair
Clear anodized

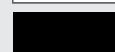

Noir
Black

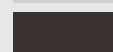

Brun commercial
Commercial brown

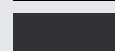

Charbon
Slate

OPTIONS DISPONIBLES

OPTIONS AVAILABLES

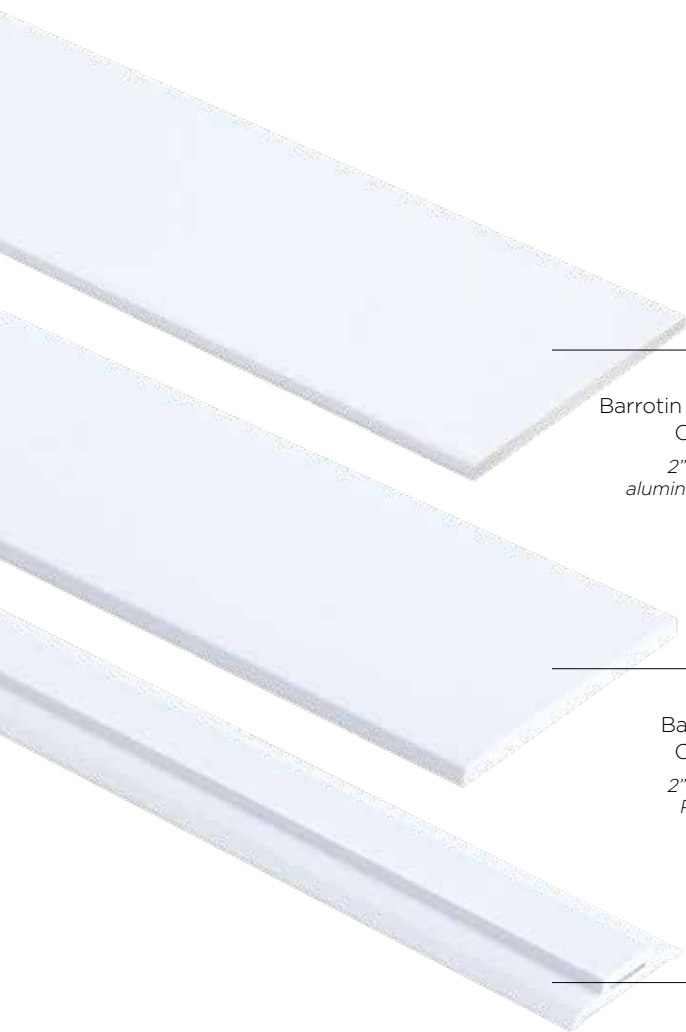

4254A
Barrotin 2" aluminium
Contemporain
*2" Contemporary
aluminium Muntin Bar*

4254I
Barrotin 2" PVC
Contemporain
*2" Contemporary
PVC Muntin Bar*

9709
Barrotin 1"
PVC Colonial
*1" Contemporary
PVC Muntin Bar*

CARRELAGE TUBULAIRE

Étain, blanc, or, argent.

*TUBULAR CAMING
Pewter, white, gold, silver.*

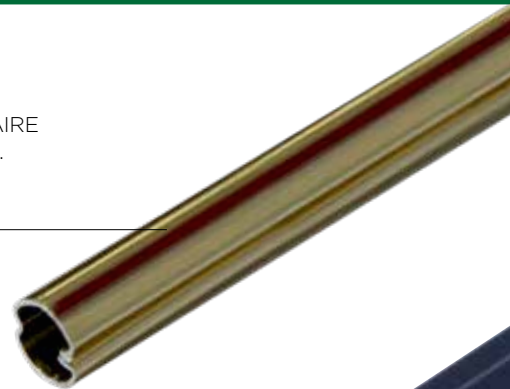

CARRELAGE GEORGIEN

5/8" , 1" OU 1^{3/4}"

Plusieurs couleurs Gentek
ou sur mesure.

*5/8" or 1" GEORGIAN GRILL
Several Gentek or
custom colours.*



CARRELAGE PLAT 5/16", 5/8", 1" ET 2"

Plusieurs couleurs Gentek
ou sur mesure.

*5/16", 5/8", 1" and 2" FLAT GRILL
Several Gentek or
custom colours.*



Soufflage intérieur
en PVC jusqu'à 10" sur
cadre 4 1/2" et jusqu'à 11 1/8" sur
cadre 5 5/8" (Rosette optionnelle)

*Interior PVC jamb extension up to
10" on 4 1/2" and up to 11 1/8" on 5 5/8" frame (Optional rosette)*



#1471
Lame de clouage pour
moulure à brique fermée
aluminium
Nailing fin for aluminum
closed brick moulding



#1477
Lame de clouage
pour cadre
hybride
Nailing fin for hybrid
frame



#9068B
Extension extérieure
en PVC 2 1/2"
2 1/2" PVC exterior
extension



#9665
Adaptateur d'aluminium
en PVC
PVC aluminum adapter



#9766
Lame de clouage
PVC nailing fin



#9668G
Moulure à brique 3/4"
en PVC
3/4" PVC brick moulding



#9091A2B
Moulure à brique **aluminium**
1 1/2" fermée
1 1/2" closed aluminum
brick moulding



#9668D
Moulure à brique en
PVC 1 1/2", fermée
1 1/2" closed PVC brick
moulding



#9668E
Moulure à brique en
PVC 2", fermée
2" closed PVC brick
moulding



#9468
Moulure à brique en
PVC 4"
4" PVC brick moulding



#9091AB
Moulure à brique en
aluminium 1 1/2", ouverte
1 1/2" open aluminum brick
moulding



#9672
Cache « J » Rénovation en
PVC (optionnel)
Renovation PVC "J" cap
(optional)



#9671
Cache « J » en PVC
(optionnel)
PVC "J" cap (optional)



#9091A3B
Moulure Rénovation en
aluminium - 3/4"
Renovation aluminum
3/4" moulding



#9800MD
Cadre en PVC avec moulure à brique intégrée 5 5/8"
(structurale seulement)
5 5/8" PVC frame, built-in brick moulding
(Structural only)



#9600MD
Cadre 4 1/2" avec moulure à brique intégrée
4 1/2" PVC frame, built-in brick moulding

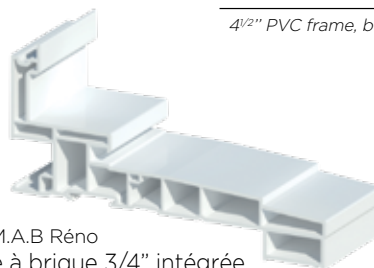

#9600MD M.A.B Réno
Cadre 4 1/2" avec moulure à brique 3/4" intégrée
4 1/2" PVC frame, 3/4" built-in brick moulding

PORTE PATIO ASTRAL 540 PVC PROMOTION

ASTRAL 540 PVC PROMOTION PATIO DOOR

*CERTAINES RESTRICTIONS S'APPLIQUENT / SOME RESTRICTIONS APPLY



**DISPONIBLE RAPIDEMENT ET
EN TOUT TEMPS**

ALWAYS AVAILABLE AND
FAST DELIVERY

**5' 3/4", 7' 1/4", 9' 3/4", 5', 6' ET / AND 8'
(EN INVENTAIRE / IN STOCK 7' 1/4", 5' ET 6')**

- Peinture noire extérieur disponible en option

Optional exterior black paint



SPÉCIFICATIONS SPECIFICATIONS



PERFORMANCES

Étanchéité à l'air <i>Air Tightness</i>	A3
Étanchéité à l'eau <i>Water Tightness</i>	360Pa
Structural	CP-30
Global	SD-R30

POIGNÉES HANDLES



Int.

Ext.

DIMENSIONS VUE EXTÉRIEURE / EXTERIOR VIEW

Hauteur <i>Height</i> : 81"	5' 58 ¹ / ₂ "	6' 70 ¹ / ₂ "	8' 94 ¹ / ₂ "
Ouverture O : Fixe X : Opérante <i>Opening</i> O: Fixed X: Operating	XO - OX	XO - OX	XO - OX

PORTE PATIO ASTRAL PLUS 630 PVC

ASTRAL PLUS 630 PVC PATIO DOOR

*CERTAINES RESTRICTIONS S'APPLIQUENT / SOME RESTRICTIONS APPLY



SPÉCIFICATIONS SPECIFICATIONS

Poignée 9600 à mortaise simple ajustable, mortaise double (option)
Adjustable 9600 single mortise handle, double mortise (optional)



Double coupe-froid aux sections coulissantes et triple protection à la rencontre
Double weatherstripping on sliding sections and triple protection on meeting section

Avec vitrage double 80/71 qui rencontre EnergyStar
With 80/71 double glass that meet EnergyStar

Volets mécaniques assemblés à 90° munis de renforts verticaux
Sashes mechanically assembled at 90° with vertical steel reinforcements

Système de roulement tandem à ajustement frontal
Tandem bearing system with frontal adjustment

Seuil en pente en PVC continu et rail de moustiquaire en aluminium anodisé - cadre de 5-1/2" à 11-3/4"
One-piece all PVC slope sill and anodized aluminum screen track - 5-1/2" to 11-3/4"

Couvercle de seuil en aluminium (option)
Aluminum sill cover (optional)

PERFORMANCES

Résistance à l'air <i>Air Tightness</i>	A3
Résistance à l'eau <i>Water Tightness</i>	330PA /B3, 400PA/B4*
Charge structurelle <i>Structural load</i>	CP40
Facilité de manœuvre <i>Operability</i>	E3
Résistance à l'entrée par effraction <i>Break-in resistance</i>	F2

*avec option de seuil relevé/with raised sill option

POIGNÉES HANDLES



Int.

Ext.

DIMENSIONS VUE EXTÉRIEURE / EXTERIOR VIEW

Hauteur <i>Height</i> : 79 1/2"	5' 59 1/2"	6' 71 1/2"	8' 95 1/2"	9' 104 5/8"	9' 107 1/4"		10' 117"	12' 140 15/16"
Hauteur <i>Height</i> : 81"	5' 58 1/2"	6' 70 1/2"	8' 94 1/2"	9' 103 1/4"	9' 105 7/8"	12' 141 3/4"	10' 114 15/16"	12' 139 1/16"
Ouverture O : Fixe X : Opérante <i>Opening</i> O: Fixed X: Operating	XO - OX	XO - OX	XO - OX	XOX	OXO	OXO	OXXO	OXXO

PORTE PATIO MARS PVC

MARS PVC PATIO DOOR

*CERTAINES RESTRICTIONS S'APPLIQUENT / SOME RESTRICTIONS APPLY



- Peinture noire intérieur disponible en option

Optional interior black paint



- Store intégré et rétractable optionnel
Optional integrated and retractable blinds

SPÉCIFICATIONS SPECIFICATIONS

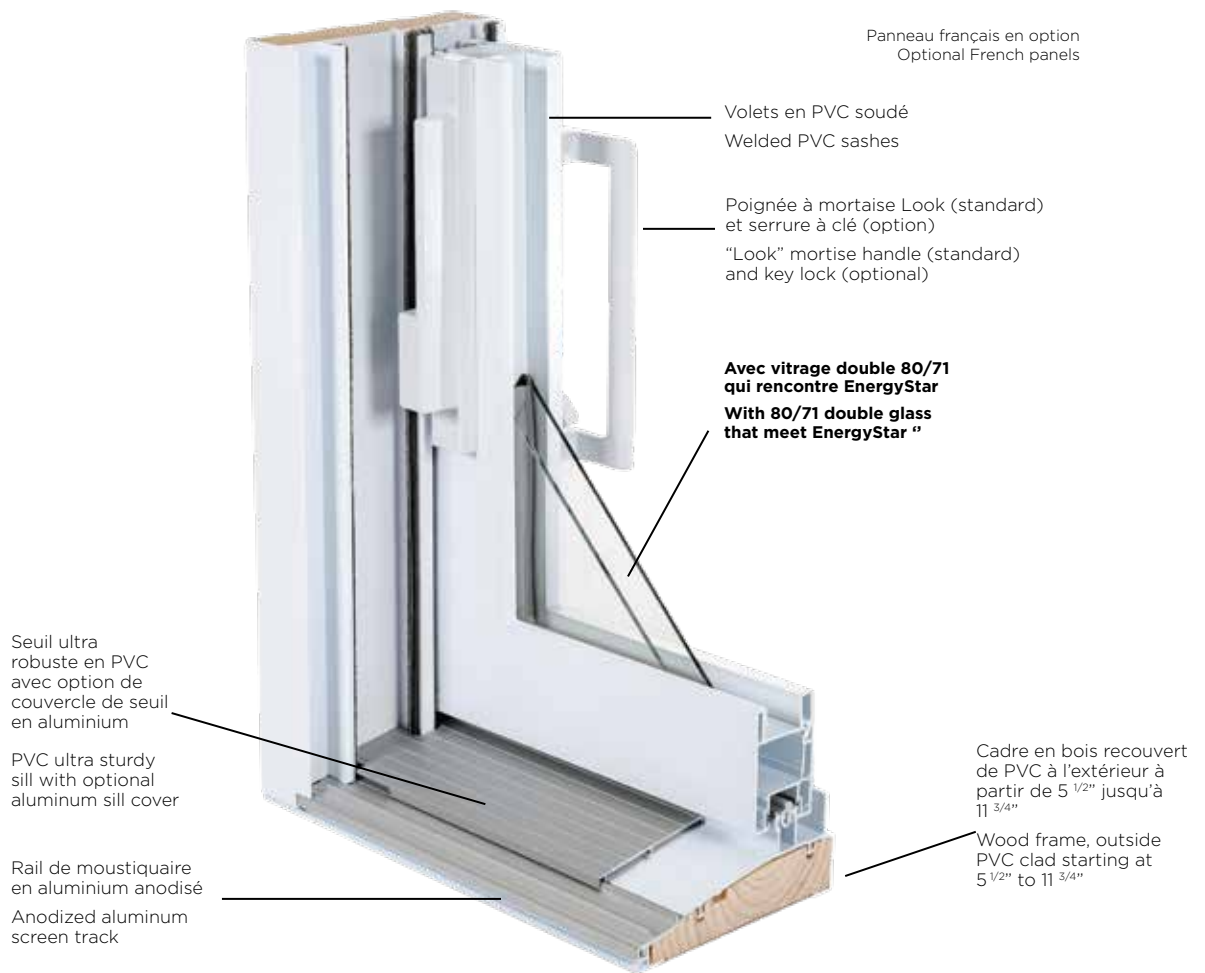

PERFORMANCES

Résistance à l'air <i>Air Tightness</i>	A3
Résistance à l'eau <i>Water Tightness</i>	400PA/B4
Charge structurelle <i>Structural load</i>	CP45
Facilité de manœuvre <i>Operability</i>	E3
Résistance à l'entrée par effraction <i>Break-in resistance</i>	F2
Rendement global <i>Overall Effectiveness</i>	PG-R45

POIGNÉES HANDLES

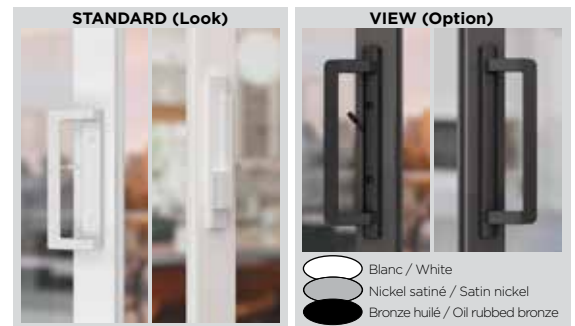

* Serrure à clé disponible dans les 2 modèles / les poignées peuvent être peintes
*Key lock available in both models / handles can be painted

DIMENSIONS VUE EXTÉRIEURE / EXTERIOR VIEW

Hauteur <i>Height</i> : 79 1/2"	5', 59 1/2"	6', 71 1/2"	8', 95 1/2"	9', 107 3/8"	9', 107 3/16"	9', 105"	10', 116 7/16"	12', 140 1/2"
Hauteur <i>Height</i> : 81"	5', 58 1/2"	6', 70 1/2"	8', 94 1/2"	9', 105 13/16"	9', 105 5/8"	9', 103 7/16"	10', 114 1/2"	12', 138 7/16"
Ouverture O : Fixe X : Opérante <i>Opening</i> O: Fixed X: Operating	XO	OX	XOO OOX	OXO	XOX	OXO	XOX	OXO

PORTE PATIO ÉLÉMENT HYBRIDE

HYBRID ALUMINUM/PVC ELEMENT PATIO DOOR

*CERTAINES RESTRICTIONS S'APPLIQUENT / SOME RESTRICTIONS APPLY



- 6 couleurs disponibles : Noir, Brun commercial, Kaki, Charbon, Anodisé clair, Blanc ou couleurs sur mesure
6 available colours : Black, Commercial brown, Pebble, Slate, Clear Anodized, white or custom colors
- Store intégré et rétractable optionnel
Optional integrated and retractable blinds

SPÉCIFICATIONS SPECIFICATIONS

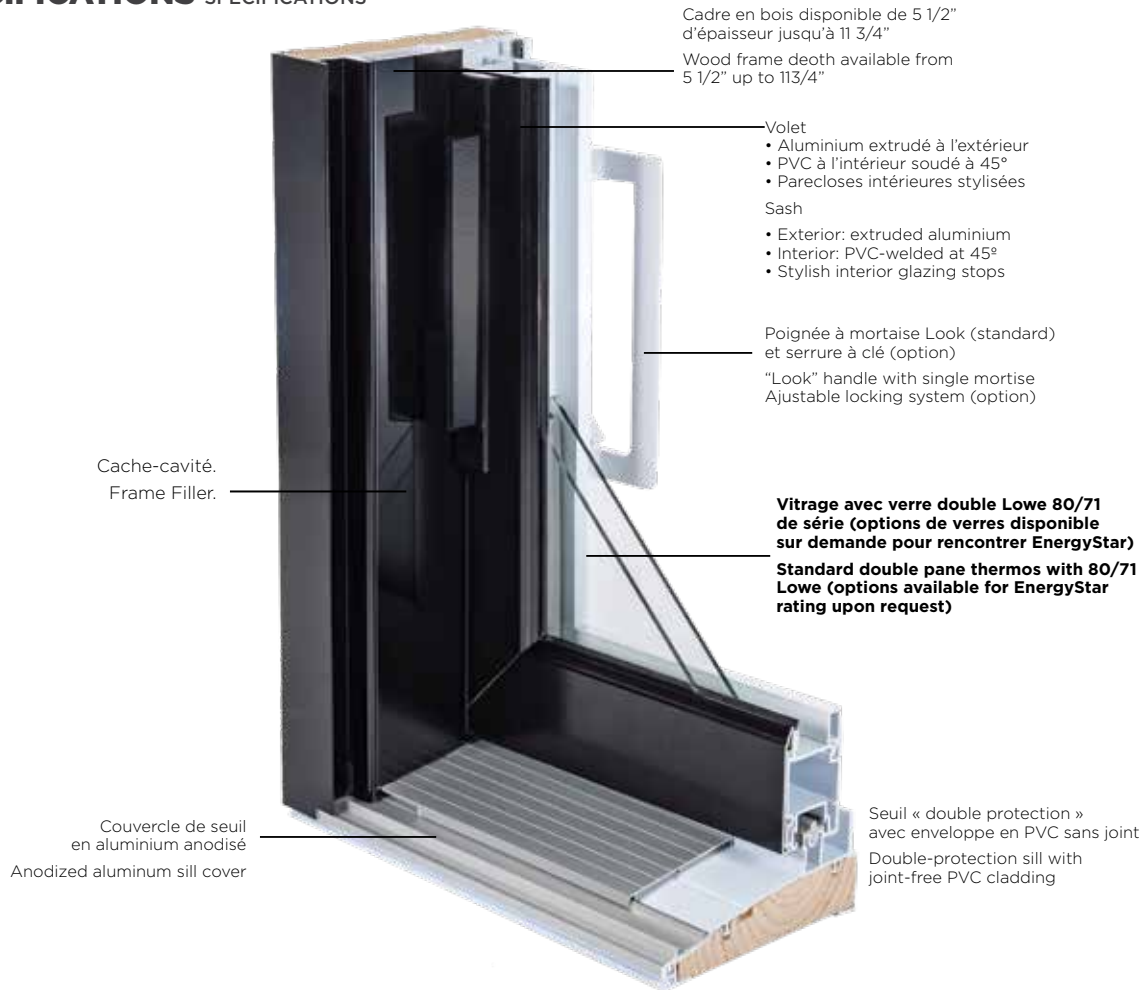

Cadre en bois disponible de 5 1/2" d'épaisseur jusqu'à 11 3/4"
Wood frame depth available from 5 1/2" up to 11 3/4"

Volet
• Aluminium extrudé à l'extérieur
• PVC à l'intérieur soudé à 45°
• Parecloses intérieures stylisées

Sash
• Exterior: extruded aluminium
• Interior: PVC-welded at 45°
• Stylish interior glazing stops

Poignée à mortaise Look (standard) et serrure à clé (option)

"Look" handle with single mortise Adjustable locking system (option)

Vitrage avec verre double Lowe 80/71 de série (options de verres disponible sur demande pour rencontrer EnergyStar)

Standard double pane thermos with 80/71 Lowe (options available for EnergyStar rating upon request)

Seuil « double protection » avec enveloppe en PVC sans joint
Double-protection sill with joint-free PVC cladding

PERFORMANCES

Normes canadiennes <i>Canadian standards</i>	CAN/CGSB-82.1-M89
Étanchéité à l'air <i>Air Tightness</i>	A3
Étanchéité à l'eau <i>Water Tightness</i>	400PA/B4
Résistance au vent <i>Wind Resistance</i>	CP50
Fonctionnement <i>Operability</i>	E3
Entrée par effraction <i>Break-in resistance</i>	F2
Rendement global <i>Overall Effectiveness</i>	PG-R50

POIGNÉES HANDLES

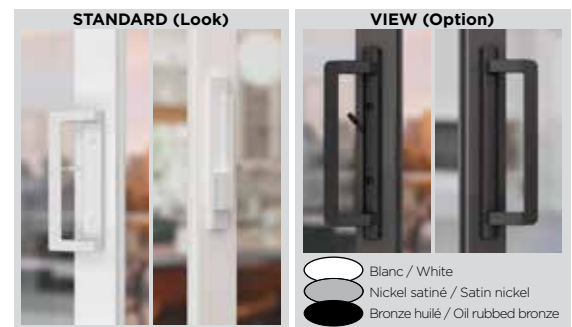

* Serrure à clé disponible dans les 2 modèles / les poignées peuvent être peintes
*Key lock available in both models / handles can be painted

DIMENSIONS VUE EXTÉRIEURE / EXTERIOR VIEW

Hauteur Height : 79 1/2"	5' 59 1/2"	6' 71 1/2"	N/D	8' 95 1/2"	9' 105"	9' 107 3/16"	N/D	10' 116 7/16"	12' 140 1/2"
Hauteur Height : 81"	5' 58 1/2"	6' 70 1/2"	7' 82 1/2"	8' 94 1/2"	9' 103 7/16"	9' 105 5/8"	12' 141 5/8"	10' 114 1/2"	12' 138 7/16"
Hauteur : 95 1/2"	5' 59 1/2"	6' 71 1/2"	N/D	8' 95 1/2"	9' 105"	9' 107 3/16"	N/D	10' 116 7/16"	12' 140 1/2"
Ouverture O : Fixe X : Opérante Opening O: Fixed X: Operating	XO - OX	XO - OX	XO - OX	XO - OX	XOX	OXO	OXO	OXXO	OXXO

PORTE PATIO URBANIA ALUMINIUM

URBANIA ALUMINIUM PATIO DOOR

*CERTAINES RESTRICTIONS S'APPLIQUENT / SOME RESTRICTIONS APPLY



Coulissante
Sliding

La porte patio en aluminium avec un design contemporain et plus de surface de verre, plus sécuritaire et facile à opérer. Elle est, en plus, certifiée Energy Star.

The aluminum patio door with a contemporary design and larger glass surface, more secure and easy to operate. Moreover, it's Energy Star certified.



- Disponible en version asymétrique
Available asymmetric version

SPÉCIFICATIONS SPECIFICATIONS

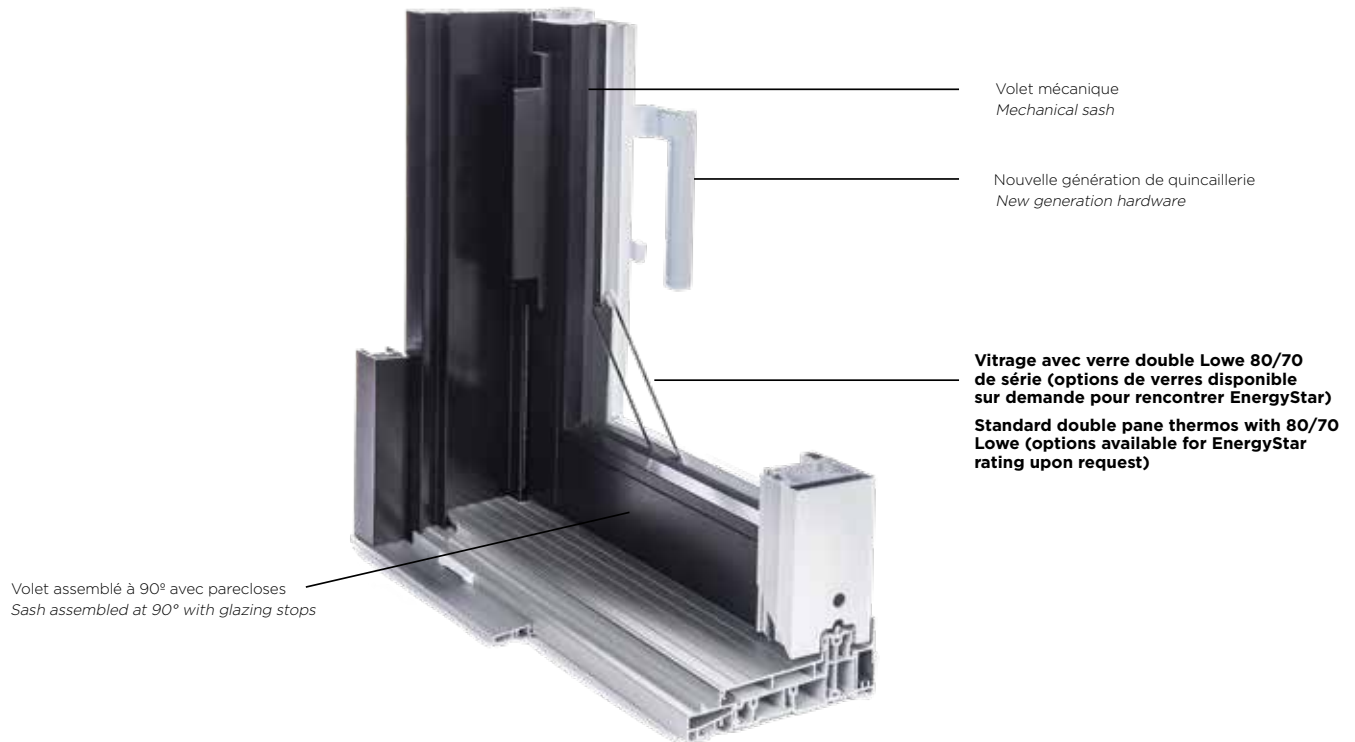

- Structural fort pour le marché de la porte patio 8 pieds de haut
Strong structure for the 8' high patio door
- Energy Star zone 3 et valeur RE de 35
Zone 3 Energy Star and RE of 35
- Rendement minimal de LC40 (8' x 8') (toutes dimensions)
LC40 (8' x 8') minimum performance (all dimensions)
- Sécurité - Double point standard
Security - Standard double point
- Fonctionnalité - Roulement en douceur
Functionality - Smooth sliding
- Couleurs standards à l'extérieur : blanc, noir. Autres couleurs disponibles sur demande
Standard colours on the outside: white, black. Other colours available on demand.

PERFORMANCES

Résistance à l'air <i>Air Tightness</i>	A3
Résistance à l'eau <i>Water Tightness</i>	360PA/B3
Charge structurelle <i>Structural load</i>	LC-CP40, CW-CP60*
Facilité de manœuvre <i>Operability</i>	E3
Résistance à l'entrée par effraction <i>Break-in resistance</i>	F2
Rendement global <i>Overall Effectiveness</i>	LC-CP40, CW-CP50*

*avec renfort /with reinforcement

POIGNÉES HANDLES



DIMENSIONS VUE EXTÉRIEURE / EXTERIOR VIEW

Hauteur Height : 79 1/2"	5', 59 1/2"	6', 71 1/2"	8', 95 1/2"	9', 107"
Hauteur Height : 81"	5', 58 1/2"	6', 70 1/2"	8', 94 1/2"	9', 107"
Hauteur Height : 95 1/2"	5', 59 1/2"	6', 71 1/2"	8', 95 1/2"	9', 107"
Ouverture O : Fixe X : Opérante Opening O: Fixed X: Operating			XO OX	

*Latéraux, impostes et version asymétrique disponibles début 2019

Sidelites, side panels and asymmetric version available early 2019

PORTE PATIO IMAGINE PVC

IMAGINE PATIO DOOR

*CERTAINES RESTRICTIONS S'APPLIQUENT / SOME RESTRICTIONS APPLY



- Store intégré et rétractable optionnel
Optional integrated and retractable blinds

SPÉCIFICATIONS SPECIFICATIONS

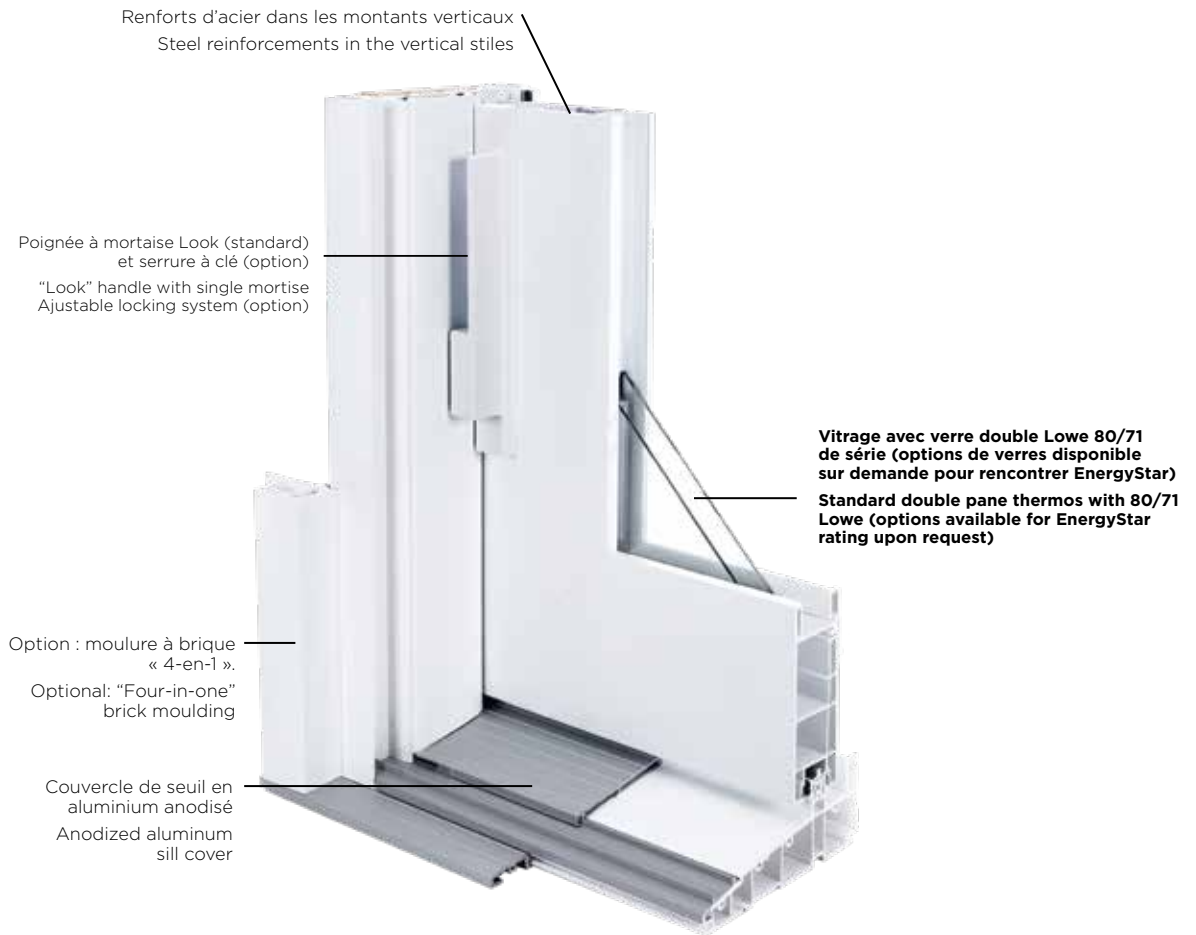

PERFORMANCES

Résistance à l'air <i>Air Tightness</i>	A3
Résistance à l'eau <i>Water Tightness</i>	400PA/B4
Charge structurelle <i>Structural load</i>	CP45
Facilité de manœuvre <i>Operability</i>	E3
Résistance à l'entrée par effraction <i>Break-in resistance</i>	F2
Rendement global <i>Overall Effectiveness</i>	PG-R45

POIGNÉES HANDLES

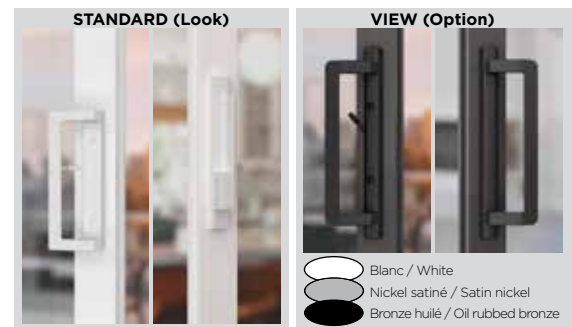

* Serrure à clé disponible dans les 2 modèles / les poignées peuvent être peintes
*Key lock available in both models / handles can be painted

DIMENSIONS VUE EXTÉRIEURE / EXTERIOR VIEW

Hauteur <i>Height</i> : 79 1/2"	5', 59 1/2"	6', 71 1/2"	8', 95 1/2"	9', 104"	9', 107 7/8"	9', 104"	10', 116 1/2"	12', 140 9/16"
Hauteur <i>Height</i> : 81"	5', 58 1/2"	6', 70 1/2"	8', 94 1/2"	9', 102 9/16"	9', 106 7/16"	9', 102 9/16"	10', 114 5/8"	12', 138 11/16"
Ouverture O : Fixe X : Opérante <i>Opening</i> O: Fixed X: Operating	XO	OX	XOO	OOX	OXO	XOX	OXXO	

PORTE PATIO LOFT ALUMINUM

LOFT ALUMINIUM PATIO DOOR

*CERTAINES RESTRICTIONS S'APPLIQUENT / SOME RESTRICTIONS APPLY



Levante et coulissante
Lift and Slide

La porte patio en aluminium avec un design contemporain et plus de surface de verre, plus sécuritaire et facile à opérer. Elle est, en plus, certifiée Energy Star.

The aluminum patio door with a contemporary design and larger glass surface, more secure and easy to operate. Moreover, it's Energy Star certified.



- Disponible en version asymétrique
Available asymmetric version

SPÉCIFICATIONS SPECIFICATIONS



- Structural fort pour le marché de la porte patio 8 pieds de haut
Strong structure for the 8' high patio door
- Energy Star zone 3 et valeur RE de 35
Zone 3 Energy Star and RE of 35
- Rendement minimal de LC40 (8' x 8') (toutes dimensions)
LC40 (8' x 8') minimum performance (all dimensions)

- Nouvelle génération de quincaillerie
New generation hardware
- Sécurité - Triple point d'arrimage
Security - Triple Locking Points
- Esthétisme - Poignée de levage moderne
Appearance - Modern Lift Handle

- Fonctionnalité - Roulement en douceur
Functionality - Smooth sliding
- Couleurs standards à l'extérieur : blanc, noir. Autres couleurs disponibles sur demande
Standard colours on the outside: white, black. Other colours available on demand.

PERFORMANCES

Résistance à l'air <i>Air Tightness</i>	A3
Résistance à l'eau <i>Water Tightness</i>	360PA/B3
Charge structurelle <i>Structural load</i>	LC-CP40, CW-CP60*
Facilité de manœuvre <i>Operability</i>	E3
Résistance à l'entrée par effraction <i>Break-in resistance</i>	F2
Rendement global <i>Overall Effectiveness</i>	LC-CP40, CW-CP50*

*avec renfort /with reinforcement

POIGNÉES HANDLES



DIMENSIONS VUE EXTÉRIEURE / EXTERIOR VIEW

Hauteur Height : 79 1/2"	6', 71 1/2"	8', 95 1/2"	9', 107"	10', 119"	12', 143"
Hauteur Height : 81"	6', 70 1/2"	8', 94 1/2"	9', 107"	10', 119"	12', 143"
Hauteur Height : 95 1/2"	6', 71 1/2"	8', 95 1/2"	9', 107"	10', 119"	12', 143"
Ouverture O : Fixe X : Opérante <i>Opening</i> O: Fixed X: Operating			XO	OX	

*Latéraux, impostes et version asymétrique disponibles début 2019
Sidelites, side panels and asymmetric version available early 2019

BIEN CHOISIR SA PORTE INTÉRIEURE

FOLLOW THESE EASY STEPS TO CHOOSE YOUR DOOR

1 ÊTES-VOUS DE STYLE CLASSIQUE OU CONTEMPORAIN ?

Le style classique exprime davantage la tradition, les structures raffinées et détaillées, tandis que le style contemporain privilégie les formes carrées, les angles droits, les ambiances minimalistes. On reconnaît le style classique dans le modèle Colonial et le style contemporain dans le modèle Shaker.

Is your style classic or contemporary?

Classic styles are more traditional, with added details built into door components. Contemporary styles feature angular shapes and minimalist lines. Our Colonial models offer more classic character, while Shaker models are more contemporary.

2 CHOISISSEZ VOTRE MODÈLE EN FONCTION DE VOTRE BUDGET.

CHOOSE YOUR MODEL ACCORDING TO YOUR BUDGET.

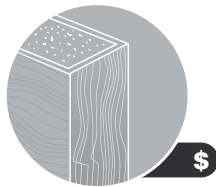

Porte à panneaux embossés
Âme vide ou pleine
*Embossed Panel Doors
Hollow/Solid Core*

Page 65

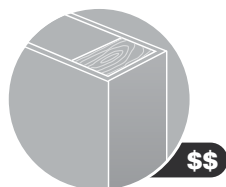

Porte en bois plaqué
Veneered Wood Door

Pages : de 62 à 64
et de 66 à 86

3 ESSENCES DE BOIS WOOD SPECIES

Essences de bois plaqué
Veneered Wood Species



APPRÊT BLANC
White Primed



CHÊNE ROUGE
Red Oak



ÉRABLE
Maple



MERISIER
Birch



PIN CLAIR
Clear Pine



PIN NOUEUX
Knotty Pine

4 VERRES GLASS

Verres Intimité Glass Privacy

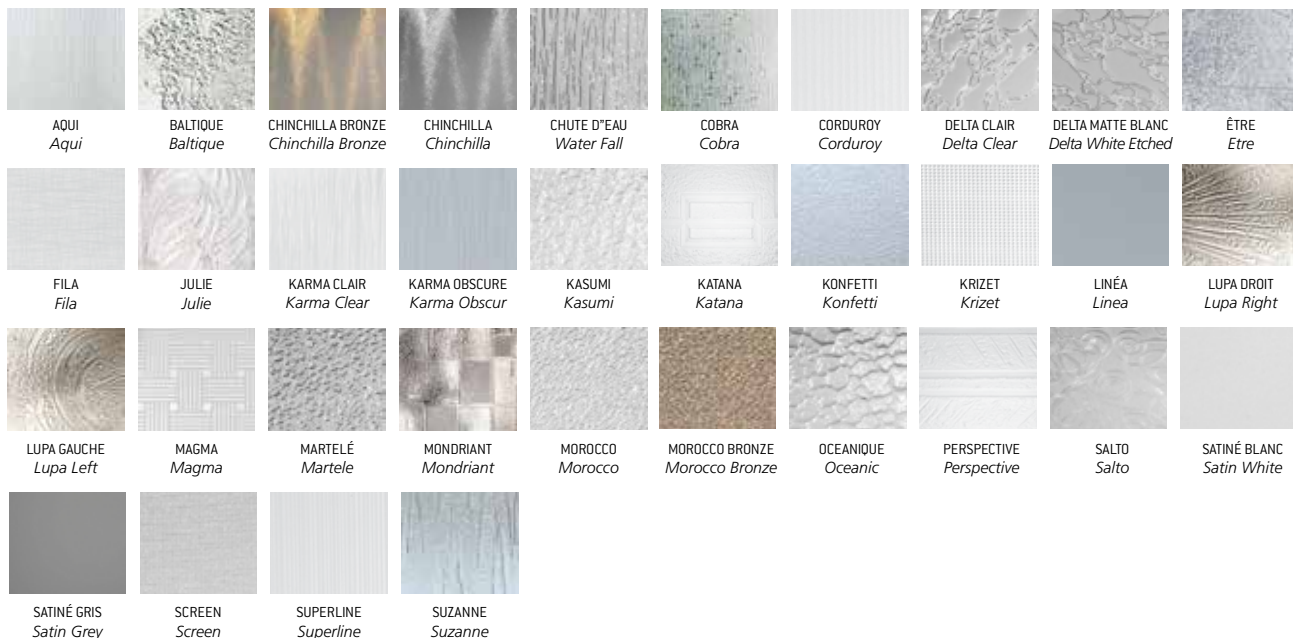

Verres Transparent Glass Clear



Verres Opaque Glass Opaque



6 DIMENSIONS

Dimensions standards Standard sizes

Portes Doors

Épaisseur *Thickness* : 1 3/8" ou 1 3/4"

Largeurs *Width* : 16" à/to 36"

Hauteur *Height* : 80" - 84" - 96"

Portes pliantes Bifold Doors

Épaisseur *Thickness* : 1 3/8"

Largeurs *Width* : 20" à/to 36"

Hauteur *Height* : 79"

ASSEMBLAGE DE VOTRE PORTE INTÉRIEURE

GET YOUR INTERIOR DOOR PREHUNG

1 HAUTEUR ET LARGEUR DES PORTES

- Mesures standards selon la série
- Sur mesure – Définissez votre largeur et votre hauteur ! (certaines restrictions s'appliquent)

DOOR WIDTH AND HEIGHT

- *Standard sizes according to door style*
- *Custom built to your measurements (some restrictions may apply)*

2 OPTIONS D'INSTALLATION

INSTALLATION OPTIONS

Préusinée / Premachined



La porte est usinée pour recevoir les pentures et la poignée selon les dimensions, standards ou sur mesure, en fonction de votre demande.

Hinges premachined and handle hole drilled as per dimensions, standard or custom, according to your needs.

Prémontée / Prehung kit

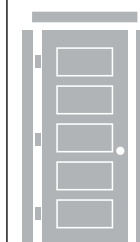

Cadre régulier avec arrêt
Frame with stopper

Cadre enfiguré
Rabbeted frame

Cette option inclut la ou les portes préusinées en plus du cadre (régulier avec arrêt ou enfiguré) et des accessoires de quincaillerie.

This option includes premachined door (or doors) plus frame (regular with stopper or rabbeted) and hardware.

3 CHOIX DE LA QUINCAILLERIE

HARDWARE OPTIONS

Penture *Hinge*

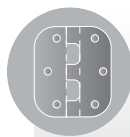

Laiton poli
Polished Brass



Nickel antique
Antique Nickel



Noir
Black



Bronze foncé
Dark Bronze



Nickel satiné
Satin Nickel



Laiton antique
Antique Brass



Zinc
zinc

Penture réversible *Reversible hinge*

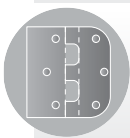

Laiton
Brass



Zinc
zinc

Coussinet à bille *Ball-catch*

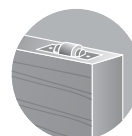

Verrous d'astragale *Flush bolt*



4 HAUTEUR ET LARGEUR DES PORTES

HEIGHT & WIDTH OF DOORS

- Impostes au-dessus d'une porte offertes dans différents modèles ainsi qu'avec plusieurs options de verre.

Transoms above doors are available in many different models and glass options.



- Modules latéraux offerts en simple ou en double pour s'harmoniser avec votre modèle de porte.

Sidelites are available in single and double door units to match any door model.





7910
Pin nouveaux plaqué/Veneered Knotty Pine



7912
Pin nouveaux plaqué/Veneered Knotty Pine



RAIL NOIR 78" DISPONIBLE EN PROMOTION PROMOTIONAL 78" BLACK RAIL AVAILABLE

- Portes 1^{3/8}" x 37" x 84" disponible en promotion : apprêt blanc, pin nouveaux plaqué et pin clair plaqué.
Promotional 1^{3/8}" x 37" x 84" doors available: White Primer, Veneered Knotty Pine and Veneered Clear Pine.

	En inventaire <i>In Stock</i>	Sur commande <i>On Order</i>
Pin nouveaux <i>Knotty pine</i>	X	
Apprêt blanc <i>White Primer</i>	X	
Pin clair <i>Clear pine</i>		X

- Dimensions de portes sur mesure disponibles sur commande spéciales.
Custom door sizes available on special order.
- Longueurs de rail sur mesure disponible sur commande spéciales.
Custom rail width available on special order.

A- Choisissez le modèle de porte

Choose the door model

Colonial

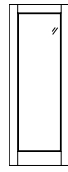

1000



1000C



1000S



1010



1010C



1010S

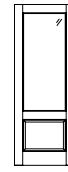

101A

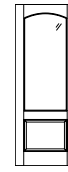

101AC

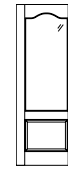

101AS

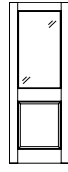

101W



101WC



101WS



101K

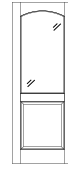

101KC

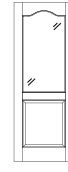

101KS

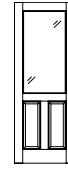

102K

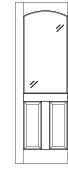

102KC

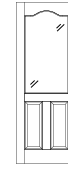

102KS

Shaker



6000

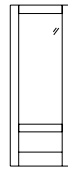

6910

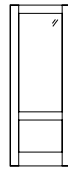

691A



691W



691K

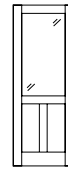

692K

E-Sticking



E000

B- Choisissez entre verre Clair ou Satiné blanc

Choose between Clear or Satin White glass



Clair
Clear



Satiné Blanc
Satin White

Côté Satiné Blanc
Satin White side

Côté Imprimé
Print side



Face Front
Verre 3mm Glass 3mm
Endos Back

C- Choisissez la dimension

Choose the size

Largeur / Width : 24" | 28" | 30" | 32" | 34" | 36"

Hauteur / Height : 80" | 84" | 96"

(Possibilité de hauteur personnalisée sur demande / Some custom heights may be available)

Épaisseur / Thickness : 1-3/8" | 1-3/4"

D- Choisissez votre couleur d'impression

Choose the print design colour

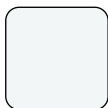

Blanc
White



Noir
Black



Rouge
Red



Jaune
Yellow



Vert
Green



Gris
Grey

E- Choisissez le thème et le style d'impression de votre verre

Choose the theme and print design

** Disponible seulement en 1000 / 6000
Disponible seulement à 80" de hauteur
Non disponible avec tête en " C " et en " S "*

** Only available in model 1000/6000
Only available 80" high
Not available in " C " and " S " shapes*

Thème : Garde-Manger



Victorian

*Bodoni

Baroque

Barattoli

Lexi

*Webster

Theme: Pantry



Victorian

*Bodoni

Baroque

Barattoli

Lexi

*Webster

Thème : Cellier



Victorian

*Bodoni

*Merlot

*Shiraz

*Webster

Thème : Gym



Victorian

*Bodoni

Lexi

*Webster

Theme: Cellar



Victorian

*Bodoni

*Merlot

*Shiraz

*Webster

Theme: Gym



Victorian

*Bodoni

Lexi

*Webster

*Illustré en pin clair, voir en page 58 pour nos options / Demonstrated in clear pine, see page 58 for options

Thème : Buanderie

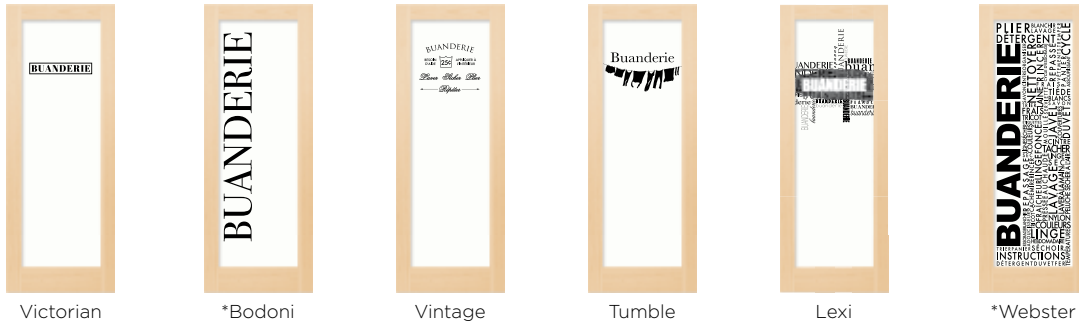

Victorian

*Bodoni

Vintage

Tumble

Lexi

*Webster

Theme: Laundry

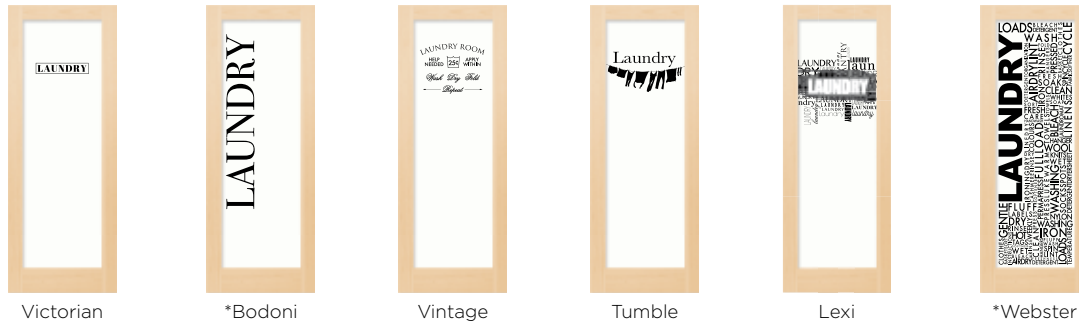

Victorian

*Bodoni

Vintage

Tumble

Lexi

*Webster

Thème : Bureau

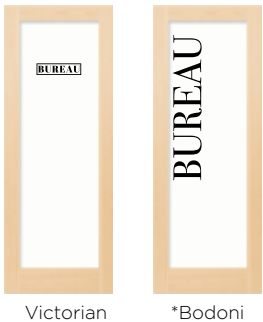

Victorian

*Bodoni

Thème : Toilette



Victorian

*Bodoni

Baroque

Theme: Office



Victorian

*Bodoni

Theme: Bathroom



Victorian

*Bodoni

Baroque



*Illustré en pin clair, voir en page 58 pour nos options / Demonstrated in clear pine, see page 58 for options

PORTES À PANNEAUX EMBOSSÉS ÂME VIDE/PLEINE

EMBOSSED PANELS DOORS - HOLLOW/SOLID CORE



Santa Fe
executive



Conmore (lisse)
Conmore (smooth)



Continental
executive



Madison (lisse)
Madison (smooth)



Berkley
Berkley



Bostonian (Texturée)
Bostonian (Textured)



Craftsman (Lisse)
Craftsman (Smooth)



Rockport (Lisse)
Rockport (Smooth)



Santa Fe (Lisse)
Santa Fe (Smooth)

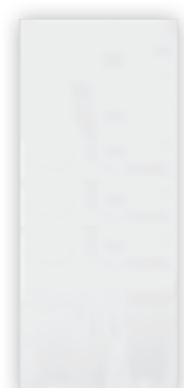

Porte unie
Flush door
Masonite apprêt blanc.
Masonite with white primer



Porte unie
Flush door
Merisier, lauan, chêne
Birch, lauan, oak.



Camden (Texturée)
Camden (Textured)
Princeton (Lisse)
Princeton (Smooth)



Continental (Lisse)
Continental (Smooth)



Cambridge (Lisse)
Cambridge (Smooth)



MONROE (Lisse)
MONROE (Smooth)



BIRKDALE (Lisse)
BIRKDALE (Smooth)

Dimensions standards Standard Sizes

Épaisseur 1³/₈"
Thickness 1³/₈"
Âme vide (Intérieur)
Hollow core (Interior)
1³/₈" et/and 1³/₄"
Âme massive agglomérée
(Coupe-son)
Solid particleboard core

(Soundproof)

1³/₄"
Coupe-feu 20 minutes
20-minute fire rated

Largeur 12" à/à 36"
Width (incrément de 2"/2" increments)
Hauteur 80", 84", 96"
Height

Portes pliantes disponibles (non illustrées),
dimensions non standards disponibles.
Bifold Doors Available (not illustrated),
non-standard sizes available.

PORTE FRANÇAISE - COLONIAL (OVOLO)

FRENCH DOOR - COLONIAL (OVOLO)



16" - 36"



3020

16" - 36"



302E

24" - 36"



303E

24" - 36"



3030

16" - 36"



3037

16" - 36"



303H

16" - 36"



303L

16" - 36"



303M

16" - 36"



3040

16" - 36"



304A

16" - 36"



304H

16" - 36"



304L

16" - 36"



304M

16" - 36"



3050

16" - 36"



305H

*Illustré en pin clair, voir en page 58 pour nos options / Demonstrated in clear pine, see page 58 for options



16" - 36"



305L

24" - 36"



3060

20" - 36"



3067

20" - 36"



306Y

20" - 36"



3080

20" - 36"



308A

20" - 36"



308Y

28" - 36"



3090

28" - 36"



3097

24" - 36"



3093

24" - 36"



3094

20" - 36"



3100

28" - 36"



3120

28" - 36"



312A

28" - 36"



3150

PORTE FRANÇAISE - SHAKER

FRENCH DOOR - SHAKER



16" - 36"



8020

16" - 36"



802E

24" - 36"



803E

16" - 36"



803H

16" - 36"



803L

16" - 36"



804H

16" - 36"



804L

16" - 36"



805H

16" - 36"



805L

PORTE FRANÇAISE - E-STICKING

FRENCH DOOR - E-STICKING



16" - 36"



G020

16" - 36"



G02E

16" - 36"



G03H

16" - 36"



G04H

16" - 36"



G05H

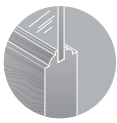

PORTE PLIANTE FRANÇAISE - COLONIAL (OVOLO)

FRENCH BIFOLD DOOR - COLONIAL (OVOLO)

20" - 36"



3020P

20" - 36"



302EP

20" - 36"



3030P

20" - 36"



303HP

20" - 36"



303LP

20" - 36"



303MP

20" - 36"



3040P

20" - 36"



304AP

20" - 36"



304HP

20" - 36"



304LP

20" - 36"



304MP

20" - 36"



3050P

20" - 36"



305HP

20" - 36"



305LP

30" - 36"



3060P

*Illustré en pin clair, voir en page 58 pour nos options / Demonstrated in clear pine, see page 58 for options

PORTE PLIANTE FRANÇAISE - COLONIAL (OVOLO)

FRENCH BIFOLD DOOR - COLONIAL (OVOLO)



30" - 36"



306YP

30" - 36"



3080P

30" - 36"



308AP

30" - 36"



308YP

30" - 36"



3100P



PORTE PLIANTE FRANÇAISE - SHAKER

FRENCH BIFOLD DOOR - SHAKER

20" - 36"



8020P

20" - 36"



802EP

20" - 36"



803HP

20" - 36"



803LP

20" - 36"



804HP

20" - 36"



804LP

20" - 36"



805HP

20" - 36"



805LP

*Illustré en pin clair, voir en page 58 pour nos options / Demonstrated in clear pine, see page 58 for options



PORTE PLIANTE FRANÇAISE - E-STICKING

FRENCH BIFOLD DOOR - E-STICKING

20" - 36"



G020P

20" - 36"



G02EP

20" - 36"



G03HP

20" - 36"



G04HP

20" - 36"

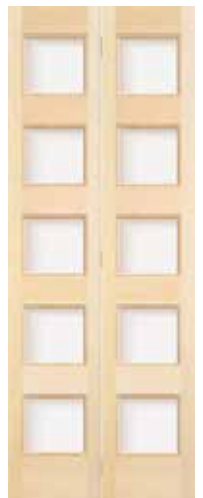

G05HP

PORTES INTÉRIEURES / INTERIOR DOORS

PORTE À PANNEAUX - COLONIAL (OVOLO)

PANEL DOOR - COLONIAL (OVOLO)

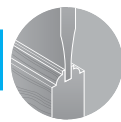

16" - 36"



🔥 2010

16" - 36"



🔥 2020

16" - 36"



🔥 202A

16" - 36"



🔥 2023

16" - 36"



🔥 202E

16" - 36"



🔥 2035

16" - 36"



🔥 2036

16" - 36"



🔥 203A

24" - 36"



🔥 203E

16" - 36"



🔥 203H

16" - 36"



🔥 203K

16" - 36"



203L

24" - 36"



🔥 2040

16" - 36"



🔥 204F

16" - 36"



🔥 204H

*Illustré en pin clair, voir en page 58 pour nos options / Demonstrated in clear pine, see page 58 for options

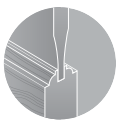

16" - 36"



204L

16" - 36"



 204Z

24" - 36"



 2050

16" - 36"



 205H

16" - 36"



205L

24" - 36"



 2060

24" - 36"



 206R

16" - 36"



 203T

24" - 36"



 206T

24" - 36"



 2080

 Disponible en porte coupe-feu 20 minutes (1¾). Sauf série «L».

 20 minutes fire-resistant doors available (1¾). Except "L" Serie.

PORTE À PANNEAUX - SHAKER

PANEL DOOR - SHAKER

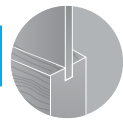

28" - 36"



791Z

16" - 36"



7910

16" - 36"



7920

16" - 36"



792A

16" - 36"



7923

16" - 36"



792E

16" - 36"



7935

16" - 36"



7936

16" - 36"



793A

24" - 36"



793E

16" - 36"



793H

16" - 36"



793K

16" - 36"



793L

16" - 36"



794F

16" - 36"



794H

*Illustré en pin clair, voir en page 58 pour nos options / Demonstrated in clear pine, see page 58 for options

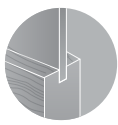

16" - 36"



794L

16" - 36"



 794Z

24" - 36"



 7940

16" - 36"



 795H

16" - 36"



795L

24" - 36"



 7950

24" - 36"



 7960

24" - 36"



 796R

16" - 36"



 793T

24" - 36"



 796T

24" - 36"



 7980



Disponible en porte coupe-feu 20 minutes (1¾). Sauf série «L».



20 minutes fire-resistant doors available (1¾). Except "L" Serie.

PORTE À PANNEAUX - E-STICKING

PANEL DOOR - E-STICKING



16" - 36"

16" - 36"

16" - 36"

16" - 36"

16" - 36"



🔥 F910



🔥 F920



🔥 F92A



🔥 F923



🔥 F92E

🔥 Disponible en porte coupe-feu 20 minutes (1¾). Sauf série «L».

🔥 20 minutes fire-resistant doors available (1¾). Except "L" Serie.



16" - 36"



 F935

16" - 36"



 F936

16" - 36"



 F93A

16" - 36"



 F93H

16" - 36"



 F93K

16" - 36"



 F94F

16" - 36"



 F94H

16" - 36"



 F94Z

24" - 36"



 F940

16" - 36"



 F95H

24" - 36"



 F960

24" - 36"



 F96R

16" - 36"



 F93T

24" - 36"

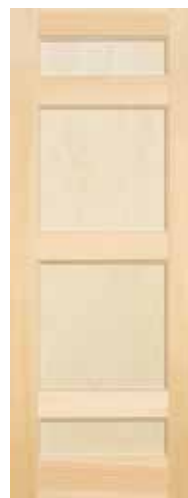

 F96T

24" - 36"



 F980

*Illustré en pin clair, voir en page 58 pour nos options / Demonstrated in clear pine, see page 58 for options

PORTE PLIANTE À PANNEAUX - COLONIAL (OVOLO)

PANEL BIFOLD DOOR - COLONIAL (OVOLO)

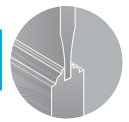

20" - 36"



2010P

20" - 36"



2020P

20" - 36"



202AP

20" - 36"



202EP

20" - 36"



2023P

20" - 36"



2035P

20" - 36"



2036P

20" - 36"



203AP

20" - 36"



203HP

20" - 36"



204LP

20" - 36"



203KP

20" - 36"



203LP

20" - 36"



203TP

20" - 36"



204FP

20" - 36"



204HP

20" - 36"



204ZP

20" - 36"



205HP

20" - 36"



205LP

*Illustré en pin clair, voir en page 58 pour nos options / Demonstrated in clear pine, see page 58 for options

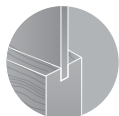

PORTE PLIANTE À PANNEAUX - SHAKER

PANEL BIFOLD DOOR - SHAKER



20" - 36"



7910P

20" - 36"



7920P

20" - 36"



792AP

20" - 36"



792EP

20" - 36"



7923P

PORTES INTÉRIEURES / INTERIOR DOORS

PORTE PLIANTE À PANNEAUX - SHAKER

PANEL BIFOLD DOOR - SHAKER



20" - 36"



7935P

20" - 36"



7936P

20" - 36"



793AP

20" - 36"



793HP

20" - 36"



793KP

20" - 36"



793LP

20" - 36"



793TP

20" - 36"



794FP

20" - 36"



794HP

20" - 36"



794LP

20" - 36"



794ZP

20" - 36"



795HP

20" - 36"



795LP



PORTE PLIANTE À PANNEAUX - E-STICKING

PANEL BIFOLD DOOR - E-STICKING

20" - 36"



F910P

20" - 36"



F920P

20" - 36"



F92AP

20" - 36"



F92EP

20" - 36"



F923P

20" - 36"



F935P

20" - 36"



F936P

20" - 36"



F93AP

20" - 36"



F93HP

20" - 36"



F93KP

20" - 36"



F93TP

20" - 36"



F94FP

20" - 36"



F94HP

20" - 36"



F94ZP

20" - 36"



F95HP

*Illustré en pin clair, voir en page 58 pour nos options / Demonstrated in clear pine, see page 58 for options

PORTE CADRE

FRAME DOOR

VERRE TREMPÉ, UNIVERRE ET SANS VERRE / TEMPERED GLASS, UNIVERRE AND WITHOUT GLASS

COLONIAL (OVOLO)

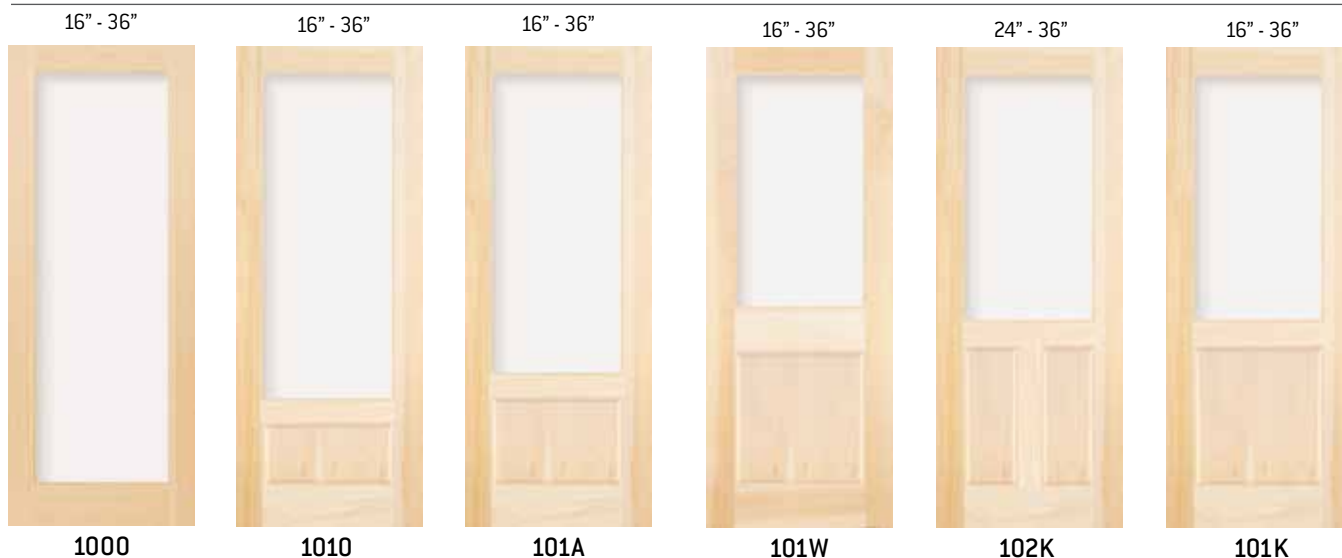

SHAKER



E-STICKING



PORTES INTÉRIEURES / INTERIOR DOORS

RENAISSANCE ET PRAIRIE / RENAISSANCE AND PRAIRIE

16" - 36"



1050

20" - 36"



1100

28" - 36"



1150

16" - 36"



1040

20" - 36"



1080

28" - 36"



1120



16" - 36"



104A0

20" - 36"



108A0

28" - 36"



112A0

PRAIRIE

24" - 36"



1J90

24" - 36"



1W90

ROYALE

16" - 36"



ATRIX CLAIR
Atrix clear

16" - 36"

16" - 36"



ATRIX OBSCURE
Atrix obscur

16" - 36"

16" - 36"



BEATRICE CLAIR
Beatrice clear

16" - 36"

16" - 36"



BEATRICE OBSCURE
Beatrice obscur

16" - 36"

16" - 36"



ESTELLE CAIR
Estelle clear

16" - 36"



ESTELLE OBSCURE
Estelle obscur

16" - 36"

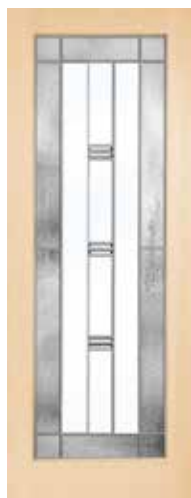

MATHEUS CLAIR
Matheus clear

16" - 36"



MATHEUS OBSCURE
Matheus obscur

16" - 36"



ROYAL BIS. CLAIR
Royal bis. clear

16" - 36"



ROYAL BISEAUTÉ
Royal bevelled



ROYAL CLAIR
Royal clear



ROYAL OBSCURE
Royal obscur

*Illustré en pin clair, voir en page 58 pour nos options / Demonstrated in clear pine, see page 58 for options

VERRE TREMPÉ / TEMPERED GLASS

COLONIAL (OVOLO)

20" - 36"



1000P

20" - 36"



1010P

20" - 36"



101AP

20" - 36"



101WP

20" - 36"



101KP

SHAKER

20" - 36"



6000P

20" - 36"



6910P

20" - 36"



691AP

20" - 36"



691WP

20" - 36"



691KP

E-STICKING

20" - 36"



E000P

*Illustré en pin clair, voir en page 58 pour nos options / Demonstrated in clear pine, see page 58 for options



DIMENSIONS

PORTES | FENÊTRES

SIÈGE SOCIAL ET USINE PRODUCTION PORTE

4065, RUE ALFRED-LALIBERTÉ
BOISBRIAND, QC
J7H 1P7

USINE PRODUCTION FENÊTRES

1029 DES ENTREPRISES OUEST
TERREBONNE, QC
J6Y 1V2

TÉL. : 450-430-4486

TÉLÉC. : 450-430-3547

SANS-FRAIS : 1-800-567-4466
INFO@DIMENSIONSPF.COM



WWW.DIMENSIONSPF.COM

DISTRIBUTEUR / DISTRIBUTOR